

# Servo Selection Guide

Automated production and life

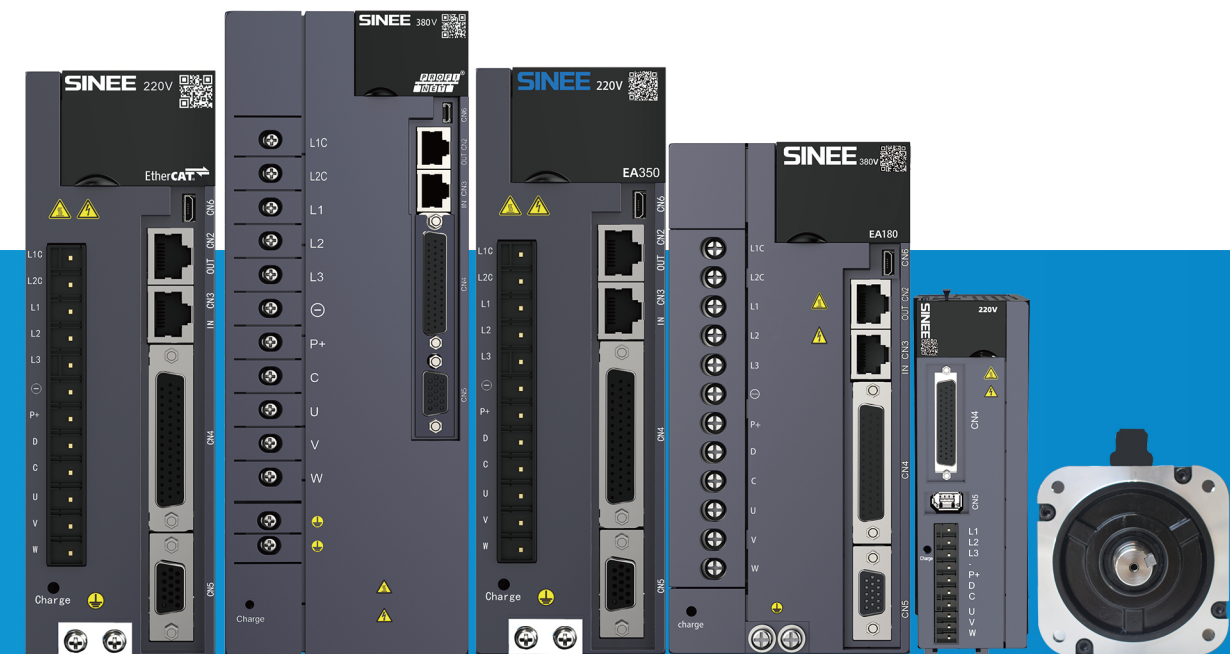

Service hotline: 027-87002560  
Official website: [www.sineedrive.com](http://www.sineedrive.com)

### Shenzhen Sine Electric Co., Ltd.

Address: Floor 5, Workshop No.7, Antuoshan Hi-Tech Industrial Park, Sha'er Community, Shajing Sub-district, Bao'an District, Shenzhen

### Wuhan Sine Electric Technology Co., Ltd

Address: 82 Gaoxin Fifth Road, East Lake High-Tech Development Zone, Wuhan

### Wuxi Branch of Shenzhen Sine Electric Co., Ltd.

Address: 6/F, Building No. 56, Huaqing Creativity Park, 33 Zihui Road, Huishan Economic Zone, Wuxi City



High integration



Compacted size



Perfect protection



Stable and reliable



## 01 Company Profile

Introduction to servo driver product line 02

## 03 EA350 series servo driver

Connection diagram of peripheral device 04 Terminal description 05

Model description and dimension diagram 06 Technical specification 08

Motor, driver and cable matching table 09

## 11 EA190 series servo driver

Connection diagram of peripheral device 12 Terminal description 13

Model description and dimension diagram 14 Technical specification 15

Motor, driver and cable matching table 16 Industry scheme 17

## 18 EA196 series servo driver

Connection diagram of peripheral device 19 Terminal description 20

Technical specification 21 dimension diagram 22

## 24 EA180C/P series servo driver

EA180C Connection diagram of peripheral device 25 EA180C Terminal description 26

EA180P Terminal description 27 Model description and dimension diagram 28

Technical specification 30 Motor, driver and cable matching table 31

## 33 EA300E series servo driver

Connection diagram of peripheral device 34 Terminal description 35

Technical specification 36 Motor, driver and cable matching table 37

## 38 EA190E series servo driver

Connection diagram of peripheral device 39 Model description and dimension diagram 40

Technical specification 41 Motor, driver and cable matching table 42

## 44 SER/SES series servo motor

Model description and common features 44 Holding brake specification 45

Installation dimension of SER series servo motor 46 Installation dimension of SES series servo motor 47

Pin distribution of the motor-side power terminal 48 Parameter table of SER series servo motor 49

Parameter table of SES series servo motor 50 Industry scheme 52





# SINEE

Since its establishment in 2003, SINEE (Shenzhen Sine Electric Co., Ltd.) has been focusing on the R&D, production and sales of motor drive and control systems in the field of industrial automation. With the mission of “automated production and life”, it provides the most valuable products and services for users. In 2021, SINEE was listed on the Science and Technology Innovation Board of the Shanghai Stock Exchange (stock code: 688395). At present, it has R&D, production and service bases in Shenzhen, Wuhan and Wuxi.

## Automated production and life

SINEE has established key core technology platforms such as high-performance variable frequency vector control technology, high-precision servo drive technology, embedded computer control technology, and power electronic application technology. It mainly provides inverters, integrated units, servo system products and system solutions.



### Vision

Automated production and life



### Operations

Motor drive and control system solution provider



### Customers

Mechanical equipment manufacturer, electronic control system integrator and distributor



### Competitiveness

Industry market solution and customization



# Introduction of servo driver product line

## Input device controller



Motion controller



HMI



PLC

## Servo driver



EA350  
Analog quantity and pulse type



EA190  
Pulse type



EA196  
Pulse type



EA190E  
EtherCAT bus type



EA300E  
EtherCAT bus type



EA180C  
CANopen bus type



EA180P  
PROFINET bus type

# EA350 series servo driver

Single-phase 220 V ~ 240 V 0.1~1 kW

Three-phase 220 V ~ 240 V 0.75~1.5 kW

Three-phase 340 V ~ 460 V 1.5~30 kW



High performance



High electromagnetic compatibility



Multi-functional and expandable





## Connection between EA350 analog pulse type servo driver and peripheral device

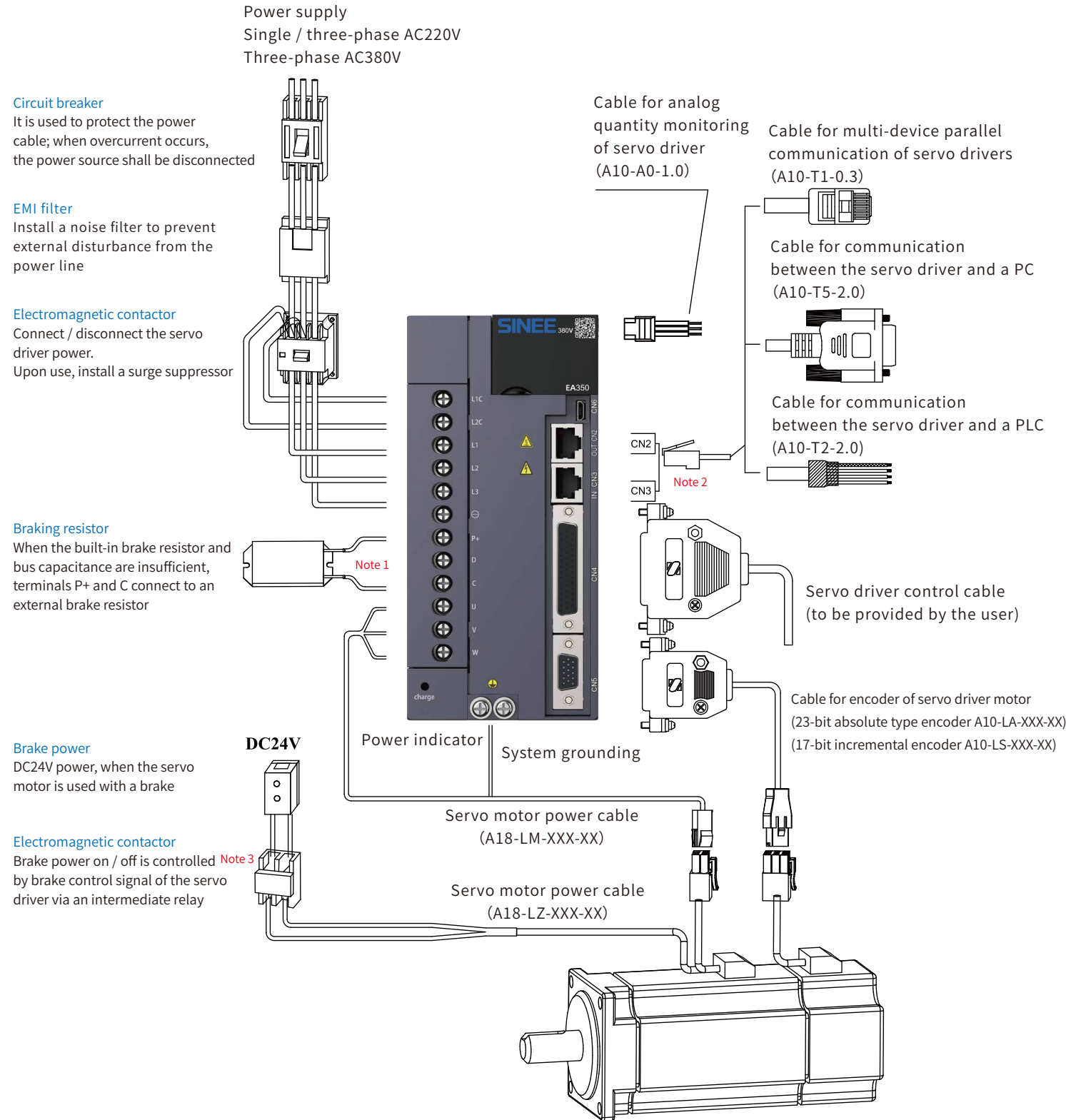

## Terminal description of EA350 analog pulse type servo driver

### Main circuit terminal

Terminal marking	Terminal name
L1C、L2C	Control power input terminal
L1、L2、L3	AC power input terminal of main circuit
P+、D、C	Connecting terminal for an external braking resistor
P+、⊖	Common DC bus terminal
U、V、W	Servo motor connecting terminal
PE	Grounding

### CN1 analog quantity monitoring terminal

Pin number	Signal name	Function
1	AO1	Output voltage 0 V ~ 10 V, Maximum output current 1mA
2	AO2	
3	GND	Common ground of analog output signal
4	Reserved	Cannot be connected with any signal line

### CN6 USB

According to USB 2.0 specification

### CN2 and CN3 communication terminals

Pin number	Signal name	Function
1	RS485+	Positive terminal of RS485 signal
2	RS485-	Negative terminal of RS485 signal
3	GND	Communication signal reference ground
4	RS232-RXD	RS232 signal receiving side
5	RS232-TXD	RS232 signal sending side

### CN4 control terminal

Signal name	Pin number	Default function
<b>Digital input</b>		
DI1	5	S-ON Servo on
DI2	20	ALM-RST Alarm fault resetting
DI3	4	P-CLR Pulse deviation counter clearing
DI4	19	P-OT Inhibit forward drive
DI5	3	N-OT Inhibit reverse drive
DI6	18	INHIBIT Pulse inhibited
DI7	2	ORPG Homing detection signal
DI8	17	SHOM Homing enable
COM+	21	DI input common positive terminal
<b>Power supply</b>		
+24V	25/40	Internal 24 V power source, with the voltage range of +20 V ~ 26 V, maximum output current 200 mA.
COM	7/22/36	
+10V	44	+10V power, maximum output of 5mA.
GND	29	
<b>Digital output</b>		
DO1	8	S-RDY+ The servo is ready and can be connected when S-ON signal status can be received
DO1-	37	S-RDY-
DO2	23	BK+ Brake control signal
DO2-	38	BK-
DO3	9	COIN+ Position reached signal
DO3-	39	COIN-
DO4	24	ALM+ Connected upon occurrence of a fault
DO4-	10	ALM-
<b>Frequency division output</b>		
PA+	28	A pulse frequency division output + Maximum current 20 mA
PA-	13	A pulse frequency division output -
PB+	12	B pulse frequency division output + Maximum current 20 mA
PB-	27	B pulse frequency division output -
PZ+	11	Z pulse frequency division output + Maximum current 20 mA
PZ-	26	Z pulse frequency division output -
OCA	43	
OCB	42	ABZ pulse open-collector output (NPN) Maximum allowable input current with GND of 40 mA
OCZ	35	
GND	29	
<b>Analog quantity</b>		
AI1	15	Analog input signal, 16-bit resolution, maximum allowable input voltage: ±12V.
AI2	30	
GND	29	Analog input signal ground
<b>Position command</b>		
PULHIP	1	Positive terminal when 24V power source is used for position pulse
PULSE+	33	Position pulse command + Way of pulse command input: Differential pulse input, open collector input
PULSE-	34	Position pulse command -
SIGN+	31	Differential position direction command + Input pulse form: Pulse + direction A, B-phase orthogonal pulse CW/CCW pulse
SIGN-	32	Differential position direction command -

### CN5 encoder terminal

Pin number	Signal name
1	SD+
3	SD-
5	+5V
10	GND
Housing	PE



### Model description of EA350 series analog pulse type servo driver

EA 350 X - 6R2 - 2 B - XX  
 ① ② ③ ④ ⑤ ⑥ ⑦

① Product Servo driver	④ Rated output current 0R9-0.9A 062-62A	⑥ Encoder type B: 17/23-bit serial encoder
② series 350 series	⑤ Rated voltage of power supply 1. Single-phase AC220 V 2. Single / three-phase AC220 V 3. Three-phase AC380 V	⑦ Non-standard specification
③ Null: standard A: 16-bit high-precision analog input		

### Dimension diagram of EA350 series analog pulse type servo driver

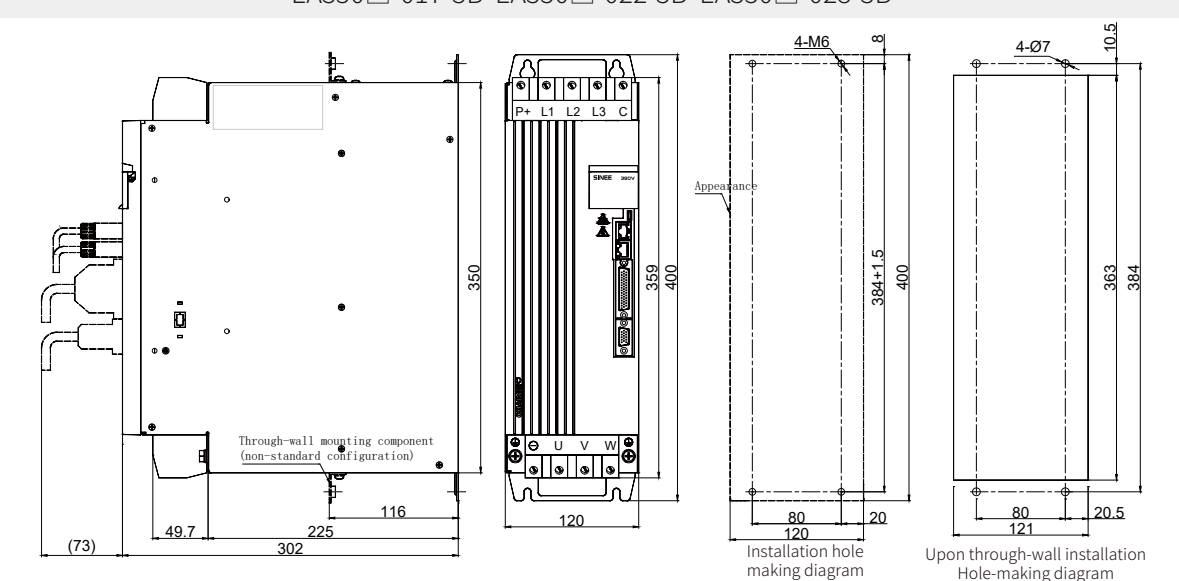
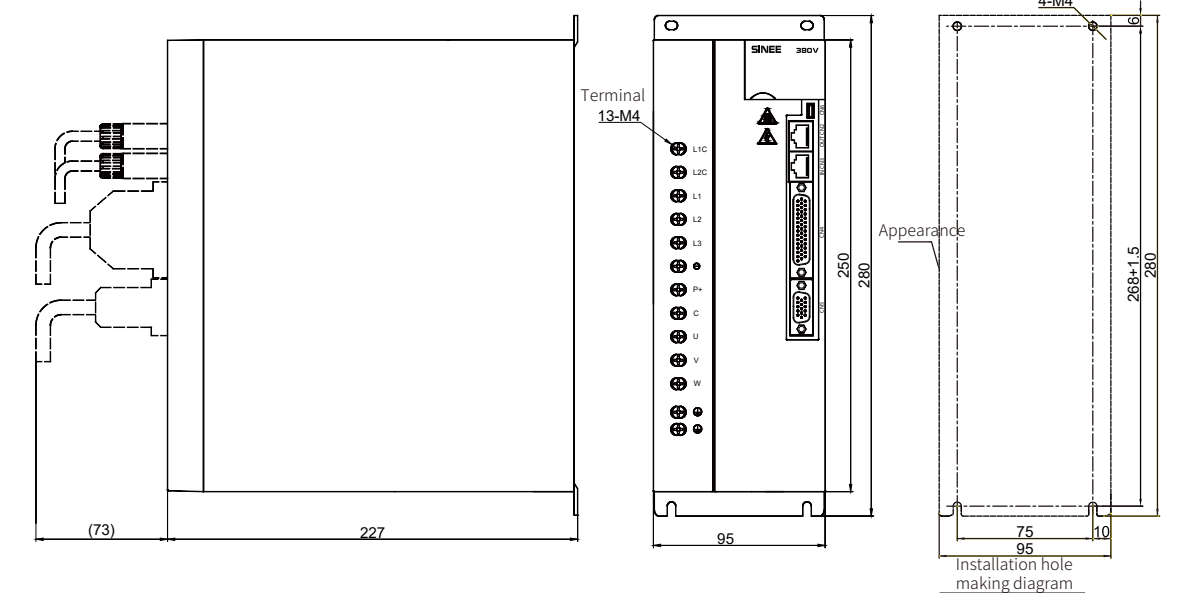
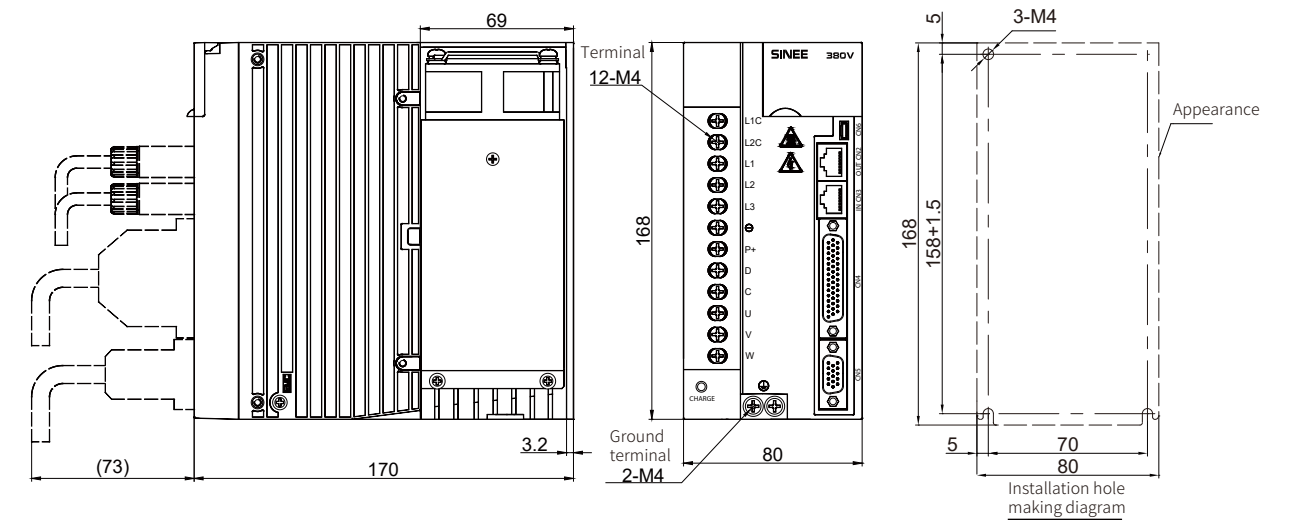
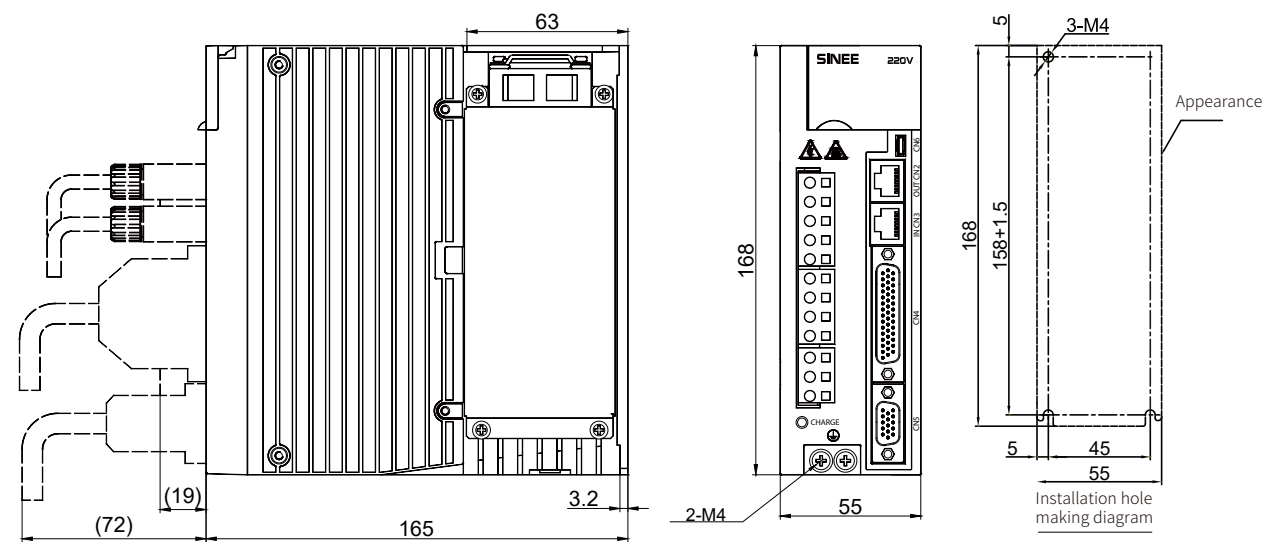
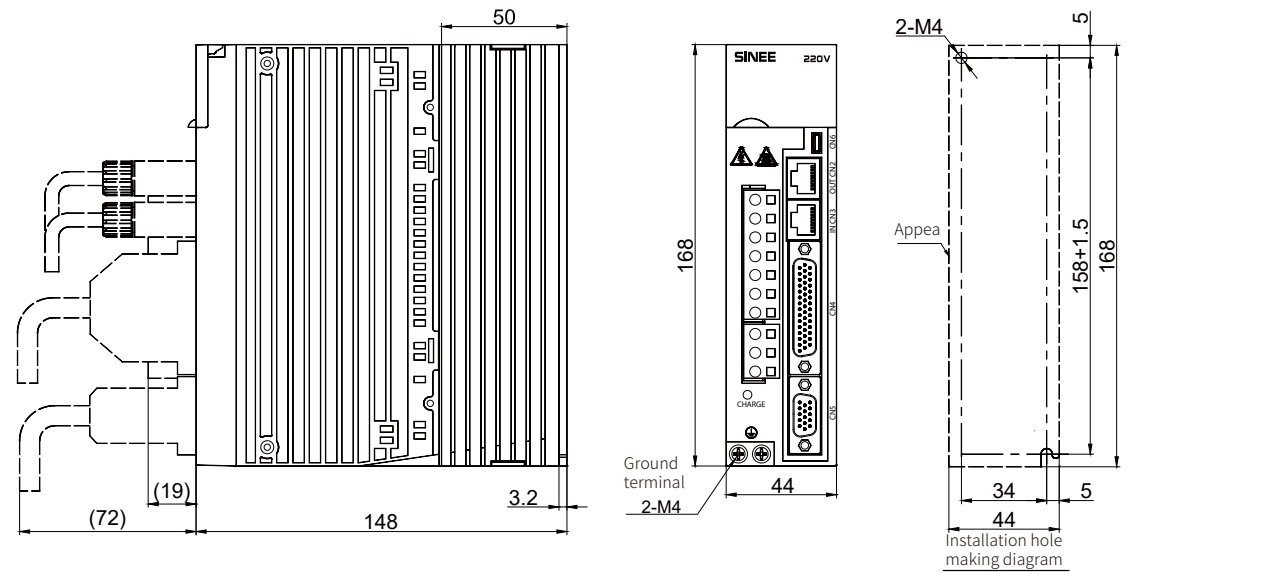





## Specification of EA350 series analog pulse type servo driver

Operating conditions	Temperature	Working temperature 0~40° , storage temperature -20° ~85°		
	Humidity	Working / storage: ≤ 90% RH (without dew condensation)		
	Altitude	≤ 1,000 m		
	Vibration	≤ 4.9 m/s <sup>2</sup> , 10~60 Hz (no operation at the point of resonance is permitted)		
Cooling method	Fan cooling			
Control method	SVPWM, vector control			
Six control modes	Speed control, position control, torque control, speed / position control, torque / speed control, position / torque control			
Front panel	5 keys, 5-digit LED			
Regenerative brake	Built-in brake unit (a built-in brake resistor is provided in partial specifications), which can have an external resistor connected			
Feedback mode	RS485 serial communication encoder, RA-CODER or FA-FORMAT protocol (non-standard version of FA-FORMAT is supported)			
Digital input/output	Input	Pulse disable, forward drive disable, reverse drive disable, forward inch, backward inch		
	Output	Servo ready, brake output, motor rotation output, zero-speed signal, speed approach, speed reached, position approach, torque limit, rotating speed limit, warning output, alarm output.		
Protective Function Software	Hardware	Over-voltage, under-voltage, over-speed, overheat, overload, over-speed, encoder alarm, and so on.		
	Software	Excessively large position error, EEPROM fault, and so on.		
Alarm data tracking function	Record 4 groups of historical alarms and relevant data			
Communication function	Modbus RTU			
Encoder signal output	Signal type	A, B, Z differential outputs, Z signal open-collector output; Z signal width can be set. A/B/Z pulse open-collector output (NPN)		
	Resolution	Any frequency division can be programmed and output before or after frequency quadruplication		
Position control mode	Maximum input pulse frequency	Differential input mode: 500 Kpps		
	Pulse command mode	Open-collector input mode: 200 Kpps		
	Command control mode	Pulse + symbol, A and B-phase orthogonal pulse, CW/CCW		
	Command smoothing mode	External pulse command, multi-segment position command		
	Electronic gear ratio	Low-pass filtering, FIR filter, trapezoid-shaped smoothing of multi-segment position command		
	Position accuracy	Electronic gear ratio: N/M multiples (0.001 < N/M < 64000 = N: 1~2 <sup>30</sup> , M: 1~230)		
Speed control mode	Command control mode	±1 pulse command		
	Command smoothing mode	External analog quantity command, digital speed command, multistage speed command, inching command		
	Analog command input	Low-pass filtering, smooth S curve		
	Torque limit	Voltage range	-10 V ~ 10 V	
		Input impedance	10 KΩ	
		Time constant	200 μs	
	Speed regulation ratio	Digital setting or external analog quantity limit		
	Speed fluctuation ratio	Bandwidth	1:5000 (23-bit encoder) Minimal speed/rated rotating speed of continuous stable operation under the rated load	
		Load fluctuation (0~100%)	Maximum	0.1%
			Supply voltage change ±10%	Maximum
Ambient temperature (0~50° C)			Maximum	0.1%
Torque control mode	Command control mode	External analog command, digital torque command		
	Command smoothing mode	Low-pass filtering		
	Analog command input	Voltage range	-10 V ~ 10 V	
		Input impedance	10 KΩ	
		Time constant	200 μs	
	Speed limit	Digital setting or external analog quantity limit		
Accuracy	±1% (current repetition accuracy)			



## EA350 series servo motor and driver matching table

Servo driver			Motor			
EA350	Model	Supply voltage	Motor	Power wattage	Adaptable motor model	
SIZE A	 EA350-0R9-1B EA350-1R6-1B EA350-2R5-1B	Single-phase AC220V		50W 100W 200W 400W	SES04-005-30-2FAY <input type="checkbox"/> SES04-0R1-30-2FAY <input type="checkbox"/> SES06-0R2-30-2FAY <input type="checkbox"/> SES06-0R4-30-2FAY <input type="checkbox"/>	
SIZE B	 EA350-4R8-2B EA350-6R2-2B	Single-phase or three-phase AC220V		750W 1000W	SES08-0R7-30-2FAY <input type="checkbox"/> SES08-1R0-30-2FAY <input type="checkbox"/> SES13-1R0-20-2FAY <input type="checkbox"/>	
SIZE C	 EA350-5R6-3B EA350-8R5-3B EA350-013-3B	Three-phase AC380V		850W 1.3KW 1.7KW	SES13-0R8-15-3FAY <input type="checkbox"/> SES13-1R3-15-3FAY <input type="checkbox"/> SES13-1R7-30-3FAY <input type="checkbox"/> SES13-1R1-20-3FAY <input type="checkbox"/> SES13-1R7-20-3FAY <input type="checkbox"/> SES13-2R6-30-3FAY <input type="checkbox"/>	
				1.8KW 2.4KW 2.6KW 2.9KW 3.6KW	SES13-1R8-15-3FAY <input type="checkbox"/> SES13-2R4-20-3FAY <input type="checkbox"/> SES13-3R6-30-3FAY <input type="checkbox"/> SES18-2R9-15-3FAY <input type="checkbox"/>	
SIZE C	 EA350-011-2B	Three-phase AC220V		0.8KW 1.1KW 1.7KW	SES13-1R1-20-2FAY <input type="checkbox"/> SES13-0R8-15-2FAY <input type="checkbox"/> SES13-1R7-30-2FAY <input type="checkbox"/>	
SIZE D	 EA350-017-3B EA350-022-3B EA350-028-3B	Three-phase AC380V		4.4KW 5.5KW 7.5KW	SES18-4R4-15-3FAY <input type="checkbox"/> SES18-5R5-15-3FAY <input type="checkbox"/> SES18-7R5-15-3FAY <input type="checkbox"/>	
				11KW 13KW 15KW	SEC20-011-15-3FAY <input type="checkbox"/> SEC20-011-20-3FAY <input type="checkbox"/> SEC20-013-15-3FAY <input type="checkbox"/> SEC20-015-15-3FAY <input type="checkbox"/> SEC23-011-15-3FAY <input type="checkbox"/>	
SIZE E	 EA350-038-3B EA350-052-3B EA350-062-3B	Three-phase AC380V		15KW/18W/22KW/29KW	SEC23-015-15-3FAY <input type="checkbox"/> SEC23-018-15-3FAY <input type="checkbox"/> SEC23-022-15-3FAY <input type="checkbox"/> SEC23-029-15-3FAY <input type="checkbox"/>	



## EA350 series servo motor, driver and cable matching table

Motor specification/model	Adaptable driver model	Encoder cable	Motor cable	
SES04-005-30-2FAY □	EA350-0R9-1B	A10-LS-A000-m (without battery) A10-LA-A000-m (without battery)	A18-LM-A007-m (motor power cable) A10-LZ-A005-m (brake cable for motor with a brake)	
SES04-0R1-30-2FAY □	EA350-1R6-1B			
SES06-0R2-30-2FAY □	EA350-2R5-1B			
SES06-0R4-30-2FAY □	EA350-4R8-2B			
SES08-0R7-30-2FAY □	EA350-6R2-2B			
SES08-1R0-30-2FAY □	EA350-6R2-2B			
SES13-1R1-20-2FAY □	EA350-6R2-2B	A18-LS-H400-m (without battery) A18-LA-H400-m (without battery)	A18-LM-M415-m (motor power cable) A18-LZ-H405-m (Brake line)	
SES13-0R8-15-2FAY □	EA350-011-2B		A18-LM-M420-m (motor power cable) A18-LZ-H405-m (brake cable for motor with a brake)	
SES13-1R7-30-2FAY □				
SES13-0R8-15-3FAY □	EA350-5R6-3B			
SES13-1R1-20-3FAY □				
SES13-1R7-30-3FAY □	EA350-5R6-3B			
SES13-1R3-15-3FAY □				
SES13-1R8-15-3FAY □	EA350-8R5-3B			
SES13-1R7-20-3FAY □				
SES13-2R6-30-3FAY □				
SES18-2R3-15-3FAY □	EA350-013-3B			Without brake: A18-LM-M525-m (motor power cable) With brake: A10-LM-M220-m (motor power cable) A18-LZ-H405-m (motor power cable)
SES13-2R4-20-3FAY □				
SES13-3R6-30-3FAY □				
SES18-2R9-15-3FAY □	EA350-013-3B			A10-LM-M240-m (motor power cable) A18-LZ-H405-m (brake cable for motor with a brake)
SES18-3R6-20-3FAY □				
SES18-4R4-15-3FAY □	EA350-017-3B			
SES18-5R5-15-3FAY □	EA350-022-3B			
SES18-7R5-15-3FAY □	EA350-028-3B			
SEC20-011-20-3FAY □	EA350-028-3B	A10-LS-H100-m (without battery) A10-LA-H100-m (with battery)		Not provided
SEC20-011-15-3FAY □				
SEC20-015-20-3FAY □				
SEC20-013-15-3FAY □				
SEC20-015-15-3FAY □				
SEC23-011-15-3FAY □				
SEC23-015-15-3FAY □				
SEC23-018-15-3FAY □				
SEC23-022-15-3FAY □	EA350-038-3B			
SEC23-018-15-3FAY □	EA350-052-3B			
SEC23-022-15-3FAY □	EA350-062-3B			
SEC23-029-15-3FAY □				

**Note:** Type A10/A18-LA encoder cable must be selected and used if the absolute position should be memorized upon power off, and Type A10/A18-LS encoder cable may be selected and used if the absolute position should be memorized without power off.

# EA190 series servo driver

Single/three-phase 220V ~ 240V 50W ~ 1kW



High-speed response



Intelligent control



High-precision positioning



Stable and reliable





## Connection between EA190 pulse type servo driver and peripheral device

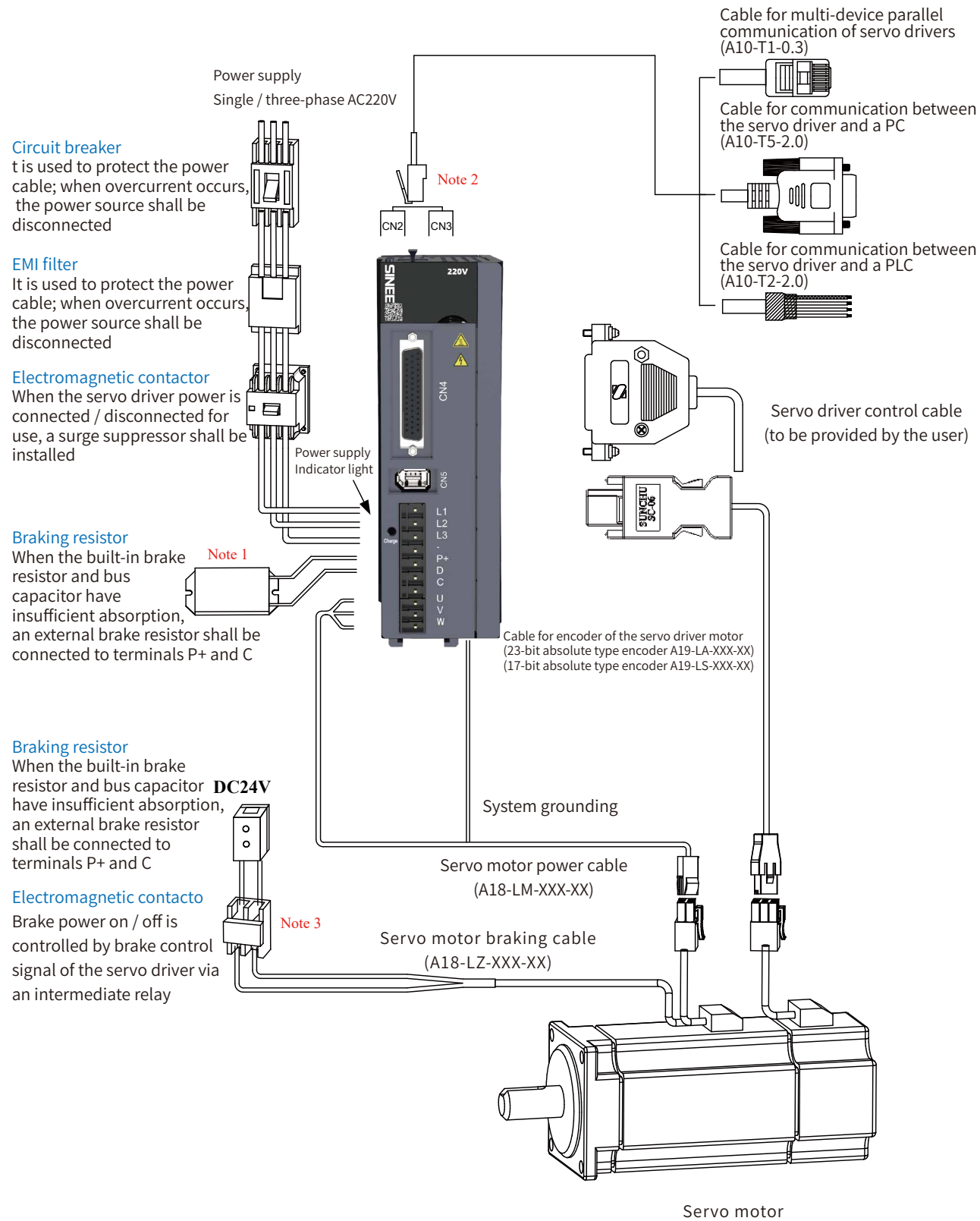

## Terminal description of EA190 pulse type servo driver

### Main circuit terminal

Terminal marking	Terminal name
L1、L2、L3	AC power input terminal
P+、D、C	Connecting terminal for an external braking resistor
P+、⊖	Common DC bus terminal
U、V、W	Servo motor connecting terminal
PE	Grounding

### CN2 and CN3 communication terminals

Pin number	Signal name	Function
1	RS485+	RS485 communication port
2	RS485-	
3	GND	RS485/RS232 communication reference ground
4	RS232-RXD	The transmitting terminal of RS232 connects to the receiving terminal of the upper computer
5	RS232-TXD	The receiving terminal of RS232 connects to the transmitting terminal of the upper computer

### CN6 USB communication terminal

### CN4 control terminal

	Signal name	Pin number	Function description
Digital input port	DI1	5	Digital input, default function No. 1
	DI2	20	Digital input, default function No. 2
	DI3	4	Digital input, default function No. 13
	DI4	19	Digital input, default function No. 14
	DI5	3	Digital input, default function No. 3
	DI6	18	Digital input, default function No. 12
	DI7	2	Digital input, default function No. 20
	DI8	17	Digital input, default function No. 21
Power supply	+24V	25/40	Digital input common positive terminal Internal 24V power source, with the voltage range of +20V ~ 26V Maximum output current 100mA
	COM	7/22/36	Internal 24V power ground; digital input common ground
Digital output	DO1	8	Digital output, default function No. 1
	DO1-	37	Digital output, default function No. 1
	DO2	23	Digital output, default function No. 2
	DO2-	38	Digital output, default function No. 2
	DO3	9	Digital output, default function No. 8
	DO3-	39	Digital output, default function No. 8
	DO4	24	Digital output, fixed function No. 12
	DO4-	10	Digital output, fixed function No. 12
	DO5	41	Digital output, with ground COM. Default function No. 0
Position pulse out/in	PULHIP	1	Positive terminal when 24V power source is used for command pulse
	PULSE+	33	Position pulse command +
	PULSE-	34	Position pulse command -
	PULHIS	16	Positive terminal when 24V power source is used for command pulse
Frequency division output	SIGN+	31	Position direction command +
	SIGN-	32	Position direction command -
	PA+	28	Differential frequency division output of pulse A, maximum allowable current 20mA
	PA-	13	Differential frequency division output of pulse A, maximum allowable current 20mA
	PB+	12	Differential frequency division output of pulse B, maximum allowable current 20mA
	PB-	27	Differential frequency division output of pulse B, maximum allowable current 20mA
	PZ+	11	Differential frequency division output of pulse B, maximum allowable current 20mA
	PZ-	26	Differential frequency division output of pulse B, maximum allowable current 20mA
	OCZ	35	Z pulse open-collector output, maximum allowable current 40mA
	GND	29	Z pulse open-collector output, maximum allowable current 40mA
OCA	43	A pulse open-collector output, maximum allowable current 40mA	
OCB	42	B pulse open-collector output, maximum allowable current 40mA	

### CN5 encoder terminal

Pin number	Signal name
1	+5V
2	GND
3	+5V
4	GND
5	SD+
6	SD-
Housing	PE



## Model description of EA190 pulse type servo driver

EA 190 X - 6R2 - 2 B - XX  
 ① ② ③ ④ ⑤ ⑥ ⑦

① Product Servo driver	④ Rated output current 0R9-0.9A 6R2-6.2A	⑥ Encoder type B: Serial communication type
② Series 190 series	⑤ Power voltage specification 1. Single-phase 220 V 2. Single / three-phase 220 V	⑦ Special specifications
③ Null: Pulse type		

## Dimension diagram of EA190 pulse type servo driver

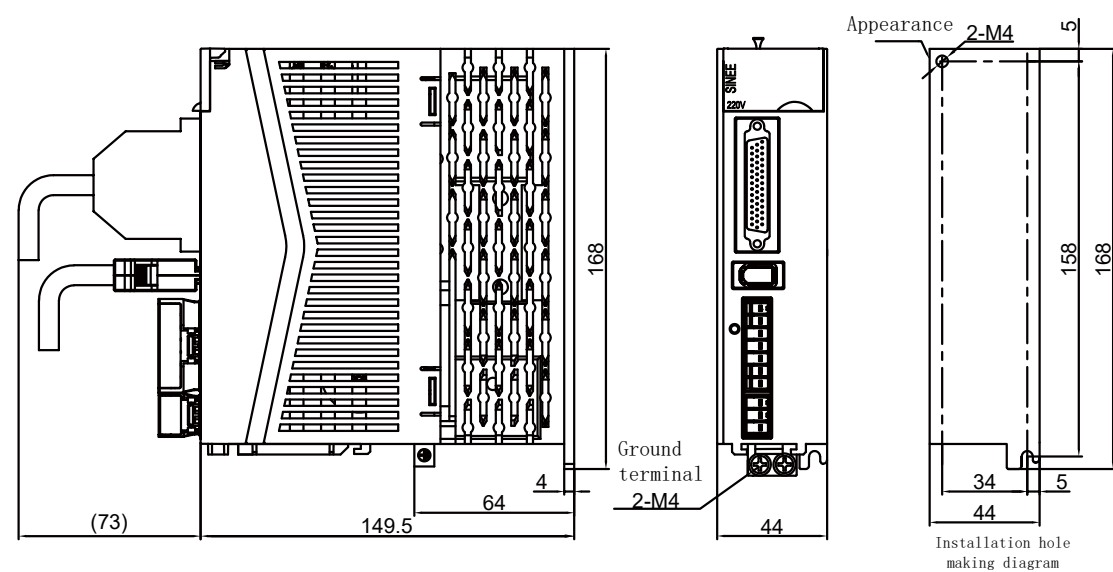

EA190□-0R9-1B EA190□-1R6-1B EA190□-2R5-1B

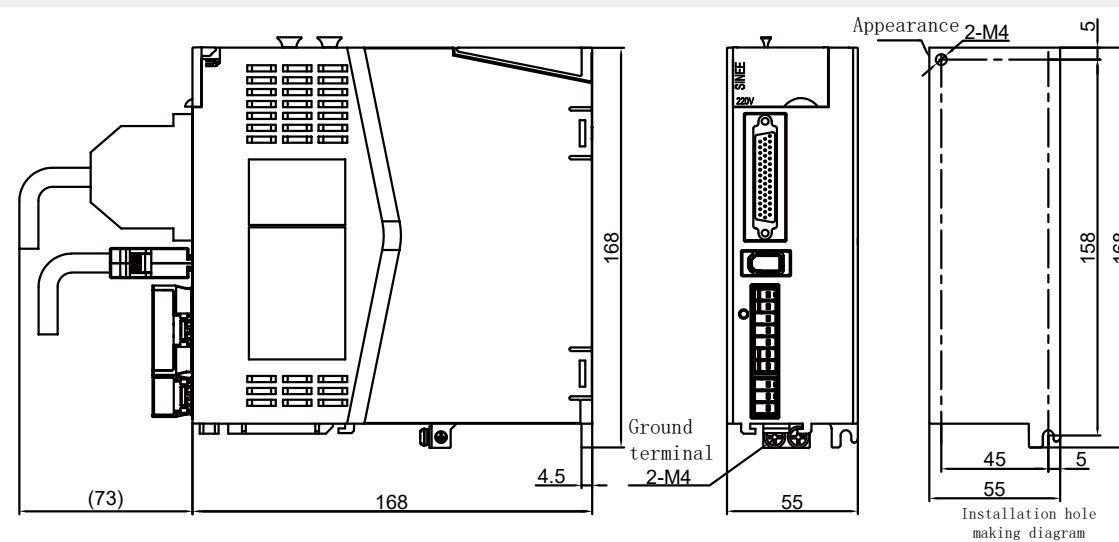

EA190□-4R8-2B EA190□-6R2-2B

## Specification of EA190 pulse type servo driver

Operating conditions	Temperature	Working temperature 0~40° , storage temperature -20° ~85°	
	Humidity	Working/storage: ≤ 90% RH (without dew condensation)	
	Altitude	≤ 1,000 m	
	Vibration	≤ 4.9 m/s <sup>2</sup> , 10~60 Hz (no operation at the point of resonance is permitted)	
Cooling method	Fan cooling		
Control method	SVPWM, vector control		
Six control modes	Speed control, position control, torque control, speed / position control, torque / speed control, position / torque control		
Front panel	5 keys, 5-digit LED		
Regenerative brake	Built-in brake unit and resistor; an external braking resistor can be connected		
Feedback mode	Support 17-bit incremental / 23-bit absolute encoder		
Digital input / output	Input	Servo start, alarm resetting, position pulse deviation counter clearing, speed command direction selection, position / speed multi-segment switching, internal command trigger, control mode switching, pulse disable, forward drive disable, reverse drive disable, forward jog, backward jog	
	Output	Servo ready, brake output, motor rotation output, zero-speed signal, speed approach, speed reached, position approach, torque limit, rotating speed limit, warning output, alarm output.	
Protective Function	Hardware	Over-voltage, under-voltage, over-speed, overheat, overload, over-speed, encoder alarm, and so on.	
	Software	Excessively large position error, EEPROM fault, and so on.	
Alarm data tracking function	Record 4 groups of historical alarms and relevant data		
Communication function	Modbus RTU		
Encoder signal output resolution	Signal type	A, B, Z differential outputs, Z signal open-collector output; Z signal width can be set.	
	Resolution	A/B/Z Pulse open collector output (NPN)	
Position control mode	Maximum input pulse frequency	Differential input mode: 500 Kpps Open-collector input mode: 200 Kpps	
	Pulse command mode	Pulse + symbol, A and B-phase orthogonal pulse, CW/CCW	
	Command control mode	External pulse command, multi-segment position command	
	Command smoothing mode	Low-pass filtering, FIR filter, trapezoid-shaped smoothing of multi-segment position command	
	Electronic gear ratio	Electronic gear ratio: N/M multiples (0.001 < N/M < 64000 = N: 1~2 <sup>30</sup> , M: 1~2 <sup>30</sup> )	
	Position accuracy	±1 pulse command	
	Command control mode	digital speed command, multistage speed command, inching command	
Speed control mode	Command smoothing mode	Low-pass filtering, smooth S curve	
	Torque limit	Digital setting limit	
	Speed regulation ratio	1:5000 (23-bit encoder)	Minimal speed/rated rotating speed of continuous stable operation under the rated load
	Bandwidth	No less than 800 Hz (in case of a 23-bit encoder)	
Speed regulation ratio	Load fluctuation (0~100%)	Maximum 0.1%	For a 23-bit encoder, when the speed command is the rated rotating speed, (rotating speed without load - rotating speed with full load) / rated rotating speed.
	Power voltage change ±10%	Maximum 0.1%	
	Environment temperature (0~50°C)	Maximum 0.1%	
Torque control mode	Command control mode	digital torque command	
	Command smoothing mode	Low-pass filtering	
	Speed limit	Digital setting limit	
	Accuracy	±3% (current repetition accuracy)	





## EA190 series servo motor and driver matching table

Servo driver			Motor		
EA190	Model	Supply voltage	Motor	Power wattage	Adaptable motor model
SIZE A	EA190 □ -0R9-1B EA190 □ -1R6-1B EA190 □ -2R5-1B	Single-phase AC220V		50W 100W 200W 400W	SES04-005-30-2HAY □ SES04-0R1-30-2HAY □ SES06-0R2-30-2HBY □ SES06-0R4-30-2HBY □
SIZE B	EA190 □ -4R8-2B EA190 □ -6R2-2B	Single-phase or three-phase AC220V		750W 1000W	SES08-0R7-30-2HBY □ SES08-1R0-30-2HBY □ SER13-1R0-10-2HBY □ SER13-1R0-20-2HBY □ SER13-1R0-30-2HBY □ SES13-1R1-20-2HBY □



## EA190 series servo motor and driver matching table

Motor specification / model	Adaptable driver model	Encoder cable	Motor cable
SES04-005-30-2HAY □	EA190□-0R9-1B	A19-LS-A000-m (without battery) A19-LA-A000-m (with battery)	A18-LM-A007-m (motor power cable) A18-LZ-A005-m (brake cable for motor with a brake)
SES04-0R1-30-2HAY □	EA190□-1R6-1B		
SES06-0R2-30-2HBY □	EA190□-2R5-1B		
SES06-0R4-30-2HBY □	EA190□-4R8-2B		
SES08-0R7-30-2HBY □	EA190□-6R2-2B	A19-LS-H100-m (without battery) A19-LA-H100-m (with battery)	Without brake: A18-LM-H115-m With brake: A18-LB-H115-m
SES08-1R0-30-2HBY □			
SER13-1R0-10-2HBY □			
SER13-1R0-20-2HBY □			
SER13-1R0-30-2HBY □			

# Intelligent logistics



## Industrial demand

Rapid development of e-commerce and cold chain logistics in China brings new opportunities for the express delivery industry. The large delivery volume has expedited construction of sorting centers for express delivery of goods, while small modular sorting equipment and systems of high flexibility and performance-cost ratio have become a focus of fast delivery enterprises.

“To accomplish each delivery” is the uppermost pursuit of delivery services. Accurate sorting is obviously a core procedure of delivery. Sorting error will not only cause inconvenience to customers, but also impair confidence of goods sellers and express delivery enterprises. Reliable intelligent sorting systems are helping distribution centers of express delivery enterprises realize “intelligent sorting, fast transfer and less people-dependent operation” of parcels.

## Highlights of the scheme

- Accurate location with a precise high-speed response controller
- Frequency division output, subject to closed-loop configuration control
- Smooth acceleration and deceleration; fast and stable parcel loading
- High sorting efficiency, with single-machine sorting speed of 6-8 K/h

## Scheme composition

EA196、EA190 series servo motor  
EtherCAT bus communication  
Customized motor cable

# EA196 series servo driver

Single-phase 220V~240V 0.2~0.75kW

 High-speed response

 High-precision positioning

 Easy to use



## Connection between EA196 pulse type servo driver and peripheral device

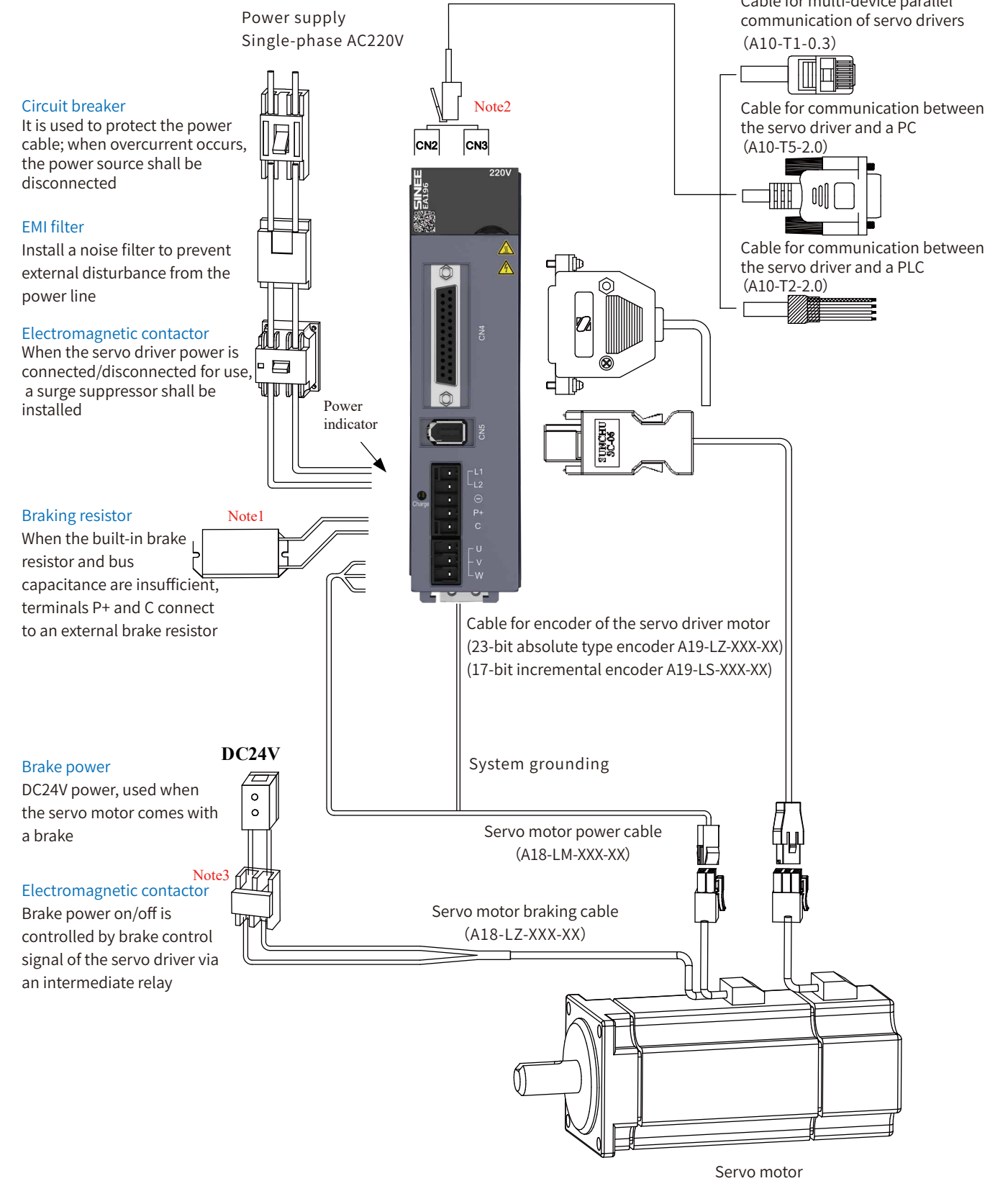

**Note 1:** When an external brake resistor is used, it is required to remove the short-circuiting piece between P+ and D, and correctly set the brake resistor parameter on the driver

**Note 2:** CN2 and CN3 are two RJ45 sockets with identically defined internal pins

**Note 3:** It is strongly recommended that the servo motor brake is defined by the servo driver as the DO terminal of the BK function for control. The DO terminal of the servo driver shall have its load capacity used only for driving an intermediate relay other than an electromagnetic contactor.



## Terminal description of EA196 pulse type servo driver

### Main circuit terminal

Terminal marking	Terminal name
L1、L2	AC power input terminal
P+、D、C	Connecting terminal for an external braking resistor
P+、θ	Common DC bus terminal
U、V、W	Servo motor connecting terminal
PE	Grounding

### CN2 and CN3 communication terminals

Pin number	Signal name	Function
1	RS485+	RS485 communication port
2	RS485-	
3	GND	RS485/RS232 communication reference ground
4	RS232-RXD	The transmitting terminal of RS232 connects to the receiving terminal of the upper computer
5	RS232-TXD	The receiving terminal of RS232 connects to the transmitting terminal of the upper computer

### CN6 USB communication terminal

### CN4 control terminal

	Signal name	Pin number	Function description
Digital input port	DI1	18	Digital input, default function No. 1
	DI2	6	Digital input, default function No. 2
	DI3	4	Digital input, default function No. 13
	DI4	17	Digital input, default function No. 14
	DI5	5	Digital input, default function No. 3
	COM+	19	Digital input common positive terminal
Power supply	+24V	7	Internal 24V power source, voltage range +20V~26V, maximum output current 100mA
	COM	16	Internal 24V power ground; digital input common ground
Digital output	DO1+	8	Digital output, default function No. 1
	DO1-	20	
	DO2+	21	Digital output, default function No. 2
	DO2-	9	
	DO3+	22	Digital output, default function No. 12
	DO3-	10	
Position pulse input	PULHIP	1	Positive terminal when 24V power source is used for command pulse
	PULSE+	15	Position pulse command +
	PULSE-	3	Position pulse command -
	SIGN+	14	Position direction command +
	SIGN-	2	Position direction command -

### CN5 encoder terminal

Pin number	Signal name
1	+5V
2	GND
3	+5V
4	GND
5	SD+
6	SD-
Housing	PE

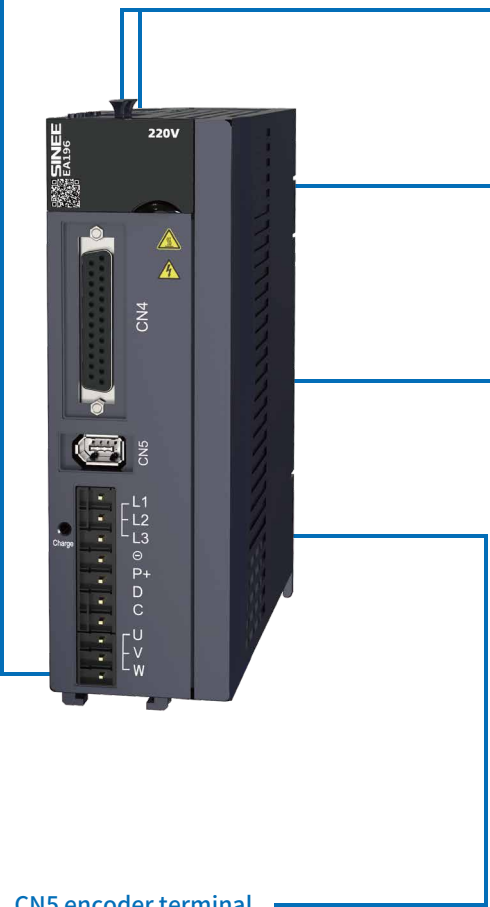



## Specification of EA196 pulse type servo driver

Operating conditions	Temperature	Working temperature 0~40° , storage temperature -20° ~85°		
	Humidity	Working/storage: ≤ 90%RH (without dew condensation)		
	Altitude	≤ 1000m		
	Vibration	≤ 4.9m/s <sup>2</sup> , 10~60Hz (no operation at the point of resonance is permitted)		
Cooling method		Fan cooling		
Control method		SVPWM, vector control		
Six control modes		Speed control, position control, torque control, speed/position control, torque/speed control, position/torque control		
Front panel		5 keys, 5-digit LED		
Regenerative brake		Built-in brake unit and resistor; an external braking resistor can be connected		
Feedback mode		17-bit incremental/23-bit absolute encoder		
Digital input/output	Input	Servo start, alarm resetting, position pulse deviation counter clearing, speed command direction selection, position/speed multi-segment switching, internal command trigger, control Mode switching, pulse disable, forward drive disable, reverse drive disable, forward inch, backward inch		
	Output	Servo ready, brake output, motor rotation output, zero-speed signal, speed approach, speed reached, position approach, torque limit, rotating speed limit, warning output, alarm output.		
Protective Function	Hardware	Over-voltage, under-voltage, over-speed, overheat, overload, over-speed, encoder alarm, and so on.		
	Software	Excessively large position error, EEPROM fault, and so on.		
Alarm data tracking function		Record 4 groups of historical alarms and relevant data		
Communication function		Modbus RTU		
Position control mode	Maximum input pulse frequency	Differential input mode: 500Kpps Open-collector input mode: 200Kpps		
	Pulse command mode	Pulse + symbol, A and B-phase orthogonal pulse		
	Command control mode	External pulse command, multi-segment position command		
	Command smoothing mode	Low-pass filtering, FIR filter, trapezoid-shaped smoothing of multi-segment position command		
	Electronic gear ratio	Electronic gear ratio: N/M multiples (0.001< N/M< 64000 = N: 1~2 <sup>30</sup> , M: 1~2 <sup>30</sup> )		
	Position accuracy	±1 pulse command		
Speed control mode	Command control mode	External pulse, digital speed command, multistage speed command, inching command		
	Command smoothing mode	Low-pass filtering, smooth S curve		
	Torque limit	Digital setting limit		
	Speed regulation ratio	1:5000 (23-bit encoder)	Minimal speed/rated rotating speed of continuous stable operation under the rated load	
	Bandwidth	No less than 400Hz (23-bit encoder)		
Speed fluctuation ratio	Load fluctuation (0~100%)	Maximum 0.1%	For a 23-bit encoder, when the speed command is the rated rotating speed, (rotating speed without load - rotating speed with full load)/rated rotating speed.	
	Supply voltage change ±10%	Maximum 0.1%		
	Environment temperature (0~50°C)	Maximum 0.1%		
Torque control mode	Command control mode	Digital torque command		
	Command smoothing mode	Low-pass filtering		
	Speed limit	Digital setting limit		
	Accuracy	±3% (current repetition accuracy)		

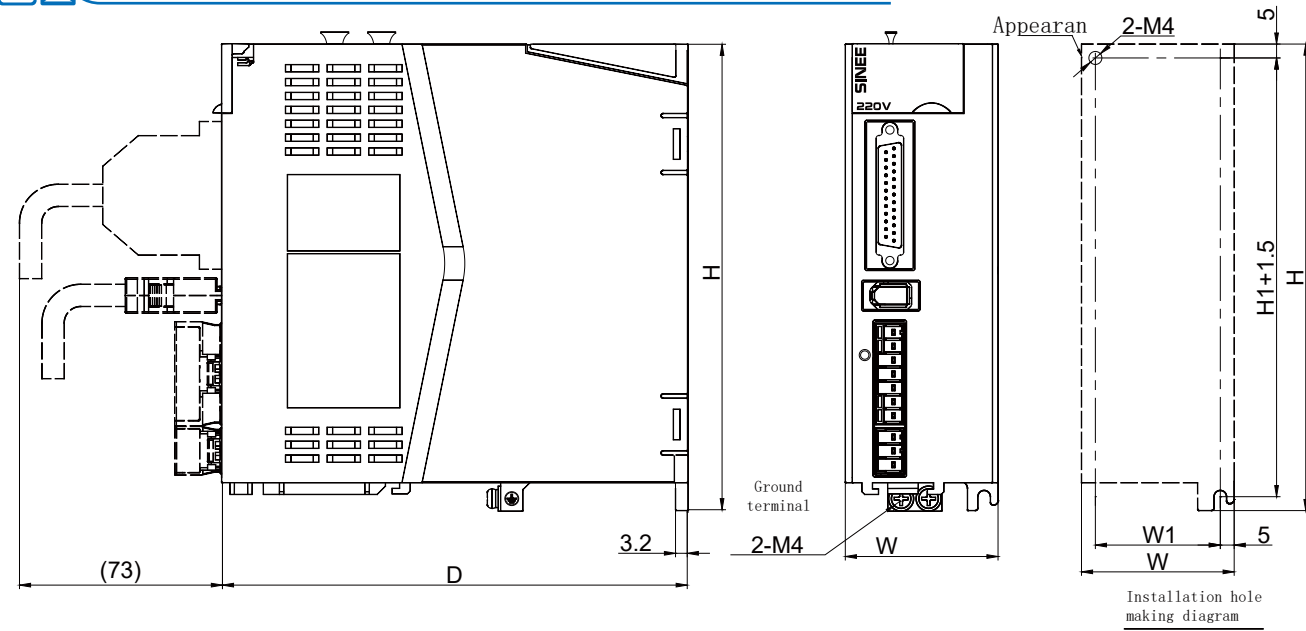
## Dimension of EA196 pulse type servo driver



## EA196 series servo motor and driver matching table

Servo driver			Motor		
EA196	Model	Supply voltage	Motor	Power	Adaptable motor model
	EA196 -2R5-1B	Single-phase AC220V		200W 400W	SES06-0R2-30-2HBY □ SES06-0R4-30-2HBY □
	EA196 -4R8-1B	Single-phase AC220V		750W	SES08-0R7-30-2HBY □

## EA196 series servo motor and driver matching table

Motor specification/model	Adaptable driver model	Encoder cable	Motor cable
SES06-0R2-30-2HBY □	EA190□-2R5-1B	A19-LS-A000-m (without battery)	A18-LM-A007-m (motor power cable)
SES06-0R4-30-2HBY □		A19-LA-A000-m (with battery)	A18-LZ-A005-m (brake cable for motor with a brake)
SES08-0R7-30-2HBY □	EA190□-4R8-2B		

# Printing & packaging

## Front-edge paper feeder

### Industrial demand

- It is the core demand of front-edge paper feeding device to make several groups of rubber axles of feed roller coordinate with paper feeding at a certain time sequence according to the real-time position of the printing roller and meet the required precision of the customer after paper feeding.

### Highlights of the scheme

- Motion controller scheme: 350 high-performance servo driver + ultra-low inertia motor + motion controller, with high speed and high accuracy of paper feeding, simple commissioning and convenient maintenance.

### Adaptable motor model

- Motion controller scheme: 350 high-performance servo driver + ultra-low inertia motor + motion controller, with high speed and high accuracy of paper feeding, simple commissioning and convenient maintenance.





# EA180C/P servo driver

Single-phase 220V~240V 0.1~1kW

Three-phase 220V~240V 0.75~1.5kW

Three-phase 340V~460V 1.5~30kW



High-speed response



Bus control



High-precision positioning



Easy to use



## Connection between EA180 CANopen bus servo driver and peripheral device

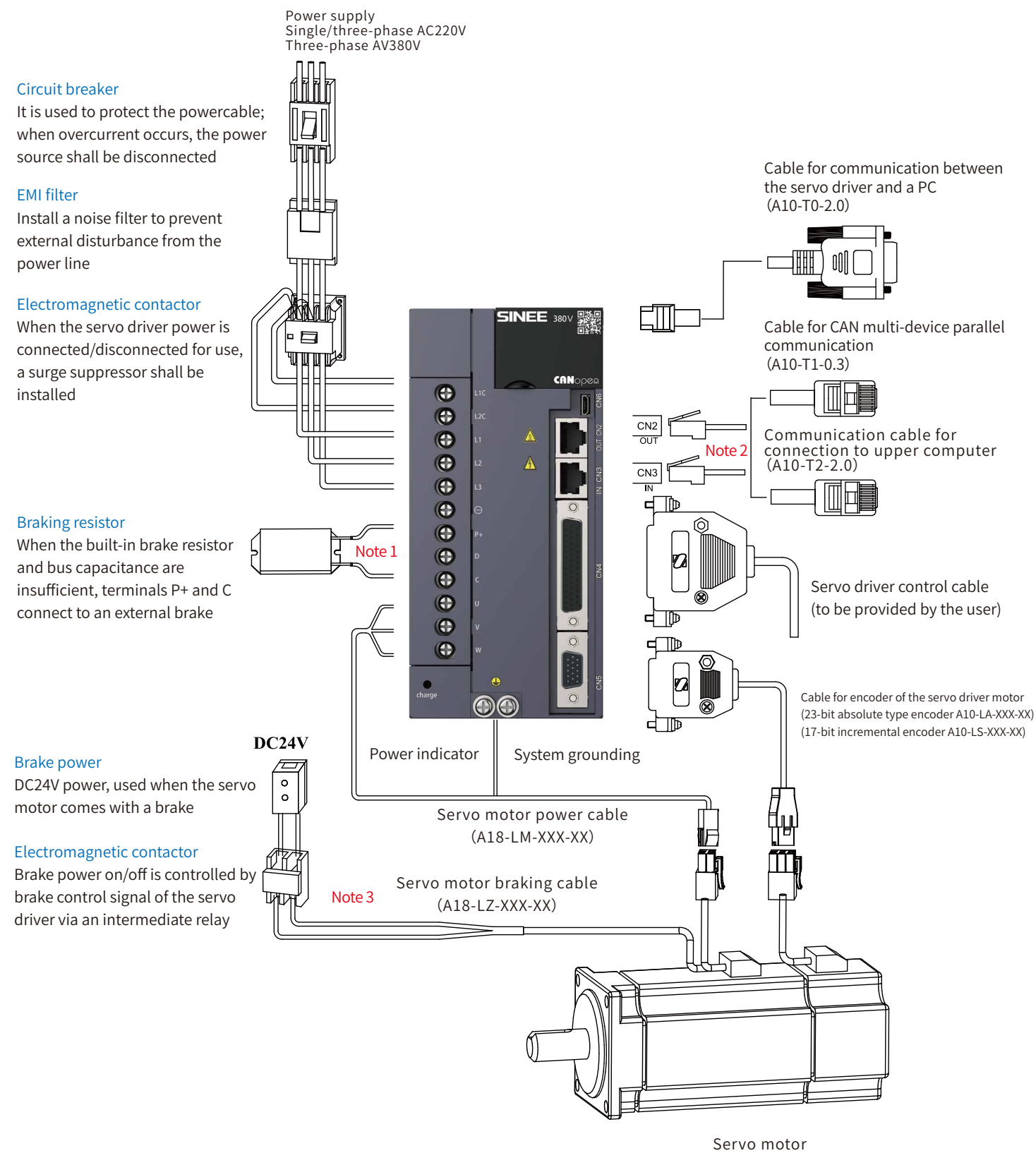

## Terminal description of EA180 CANopen servo driver

### Main circuit terminal

Terminal marking	Terminal name
L1C、L2C	Control power input terminal
L1、L2、L3	AC power input terminal of main circuit
P+、D、C	Connecting terminal for an external braking resistor
P+、⊖	Common DC bus terminal
U、V、W	Servo motor connecting terminal
PE	Grounding

### CN1 analog quantity monitoring terminal CN2 and CN3 communication terminals

Pin number	Signal name	Function
1	AO1	Output voltage 0V ~ 10V, maximum output current 1mA
2	AO2	Common ground of analog output signal
3	GND	Cannot be connected with any signal line
4	Reserved	

Pin number	Signal name	Function
1	RS485+	Positive terminal of RS485 signal
2	RS485-	Negative terminal of RS485 signal
3	GND	Communication signal reference ground
4	RS232-RXD	RS232 signal receiving side
5	RS232-TXD	RS232 signal sending side
6	GND	Communication signal reference ground
7	CANH	CAN communication reference ground
8	CANL	Negative terminal of CAN signal

### CN6 USB communication terminal

According to USB 2.0 specification

### CN4 control terminal

Signal name	Pin number	Default function
<b>Digital input port</b>		
DI1	5	S-ON Servo on
DI2	20	ALM-RST Alarm fault resetting
DI3	4	P-CLR Pulse deviation counter clearing
DI4	19	P-OT Inhibit forward drive
DI5	3	N-OT Inhibit reverse drive
DI6	18	INHIBIT Pulse inhibited
DI7	2	ORPG Homing detection signal
DI8	17	SHOM Homing enable
<b>Power supply</b>		
+24V	25/40	Internal 24V power source, voltage range +20V~26V, maximum output current 200mA
COM	7/22/36	
+10V	44	+10V power, maximum output of 10mA
<b>Digital output</b>		
DO1	8	S-RDY+ The servo is ready and can be connected when S-ON signal status can be received
DO1-	37	S-RDY-
DO2	23	BK+ Brake control signal
DO2-	38	BK-
DO3	9	COIN+ "Position reached" signal
DO3-	39	COIN-
DO4	24	ALM+ Connected upon occurrence of a fault
DO4-	10	ALM-
DO5	41	Disabled No function predefined
<b>Frequency division output</b>		
PA+	28	A pulse frequency division output + Maximum current 20mA
PA-	13	A pulse frequency division output -
PB+	12	B pulse frequency division output + Maximum current 20mA
PB-	27	B pulse frequency division output -
PZ+	11	Z pulse frequency division output + Maximum current 20mA
PZ-	26	Z pulse frequency division output -
OCZ	35	Z pulse open-collector output, maximum allowable current 40mA.
GND	29	

### CN5 encoder terminal

Pin number	Signal name
1	SD+
3	SD-
5	+5V
10	GND
Housing	PE

## Terminal description of EA180 PROFINET bus servo driver

### CN1 RS232 communication terminal

Pin number	Signal name	Function
1	RS232-TXD	RS232 signal sending side
2	RS232-RXD	RS232 signal receiving side
3	GND	RS232 communication signal reference ground
4	Reserved	Cannot be connected with any signal line

### CN2 and CN3 PROFINET communication terminals

CN3 PRFINET Port1		CN2 PRFINET Port2	
Pin number	Signal name	Pin number	Signal name
1	TD+	1	TD+
2	TD-	2	TD-
3	RD+	3	RD+
4		4	
5		5	
6	RD-	6	RD-
7		7	
8		8	

### CN4 control terminal

Signal name	Pin number	Default function
<b>Digital input port</b>		
DI1	5	P-OT Inhibit forward drive
DI2	20	N-OT Inhibit reverse drive
DI3	4	ORPG Homing detection signal
DI4	19	ALM-RST Alarm fault resetting
<b>Power supply</b>		
COM+	21	Digital input common positive terminal (12~24V)
+24V	25/40	Internal 24V power source, voltage range +20V~26V, maximum output current 200mA
COM	7/22/36	Internal 24V power ground; common negative terminal of digital input
<b>Digital output</b>		
DO1	8	S-RDY+ The servo is ready and can be connected when S-ON signal status can be received
DO1-	37	S-RDY-
DO2	23	BK+ Brake control signal
DO2-	38	BK-
DO3	9	COIN+ "Position reached" signal
DO3-	39	COIN-
DO4	24	ALM+ Connected upon occurrence of a fault
DO4-	10	ALM-

### Main circuit terminal

Terminal marking	Terminal name
L1C、L2C	Control power input terminal
L1、L2、L3	AC power input terminal of main circuit
P+、D、C	Connecting terminal for an external braking resistor
P+、⊖	Common DC bus terminal
U、V、W	Servo motor connecting terminal
PE	Grounding

### CN5 encoder terminal

Pin number	Signal name
1	SD+
3	SD-
5	+5V
10	GND
Housing	PE

**Note:** For connection between EA180P PROFINET bus servo driver and peripheral device, use connection between EA300ETHERCAT bus servo driver and peripheral device for reference.



## Model description of Series EA180C/P servo driver

EA 180 C - 6R2 - 2 B - XX  
 ① ② ③ ④ ⑤ ⑥ ⑦

① Product Servo driver	④ Rated output current 0R9-0.9A 028-28A	⑥ Encoder type B: 17/23-bit serial encoder
② Series 180 series		
③ C: CANOpen bus P: PROFINET bus	⑤ Power voltage specification 1. Single-phase 220V 2. Single/three-phase 220V 3. Three-phase 380V	⑦ Non-standard specification

Supply voltage	Driver model	Rated motor power (KW)	Rated current (A)	Maximum current (A)	Structure	Adaptive motor encoder
Single-phase 220V	EA180 □ -0R9-1 □	0.05	0.9	3.15	SIZE A	□ -B: 17/23-bit serial encoder
	EA180 □ -1R6-1 □	0.02	1.6	5.6		
	EA180 □ -2R5-1 □	0.4	2.5	9.0		
Single-phase or three-phase 220V	EA180 □ -4R8-2 □	0.75	4.8	14.4	SIZE B	
	EA180 □ -6R2-2 □	1	6.2	18.6	SIZE B	
Three-phase 220V	EA180 □ -011-2 □	1.5	11	30	SIZE C	
Three-phase 380V	EA180 □ -5R6-3 □	1.5	5.6	15	SIZE C	□ -B: 17/23-bit serial encoder
	EA180 □ -8R5-3 □	2	8.5	20		
	EA180 □ -013-3 □	3	13	30		
	EA180 □ -017-3 □	4.4	17	42.5	SIZE D	
	EA180 □ -022-3 □	5.5	22	55		
	EA180 □ -028-3 □	7.5	28	70		

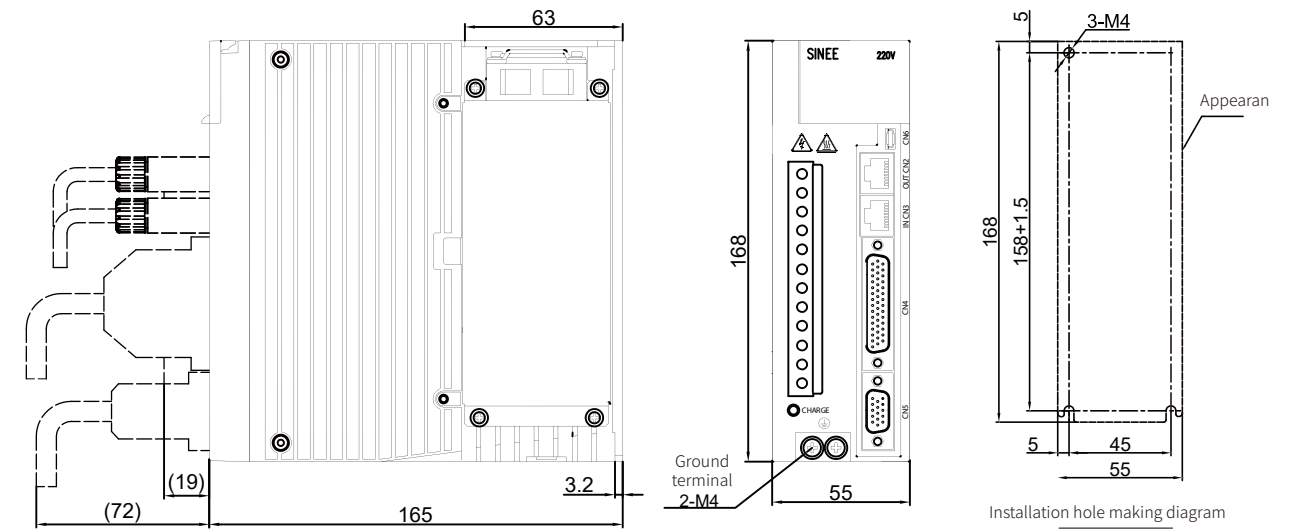

EA180□-4R8-2□ EA180□-6R2-2□

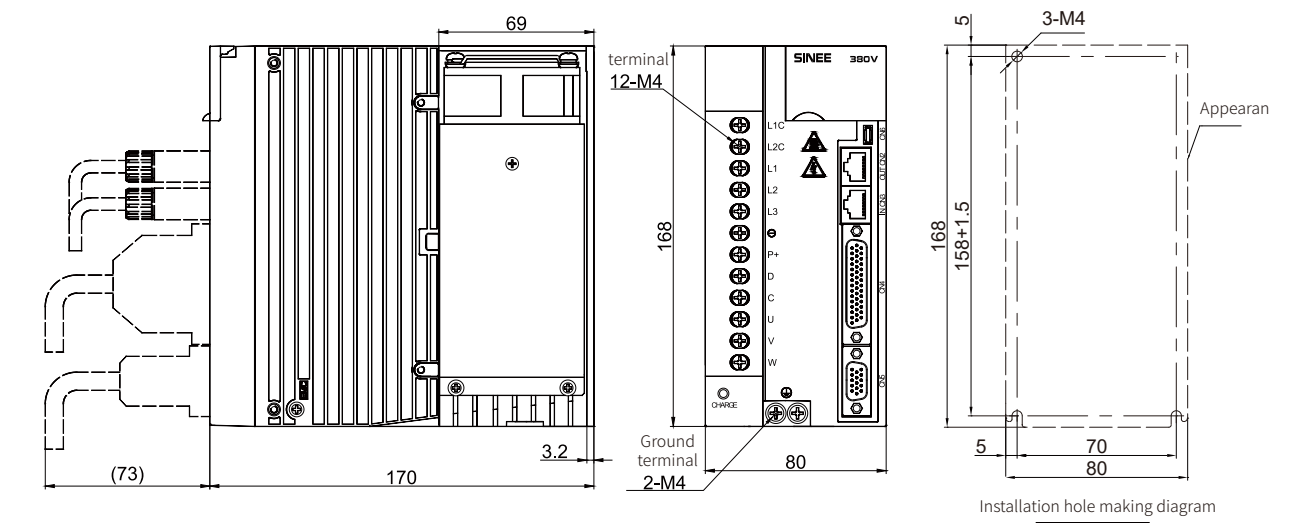

EA180□-5R6-3□ EA180□-8R5-3□ EA180□-013-3□ EA180□-011-2□

## Dimension diagram of Series EA180C/P servo driver

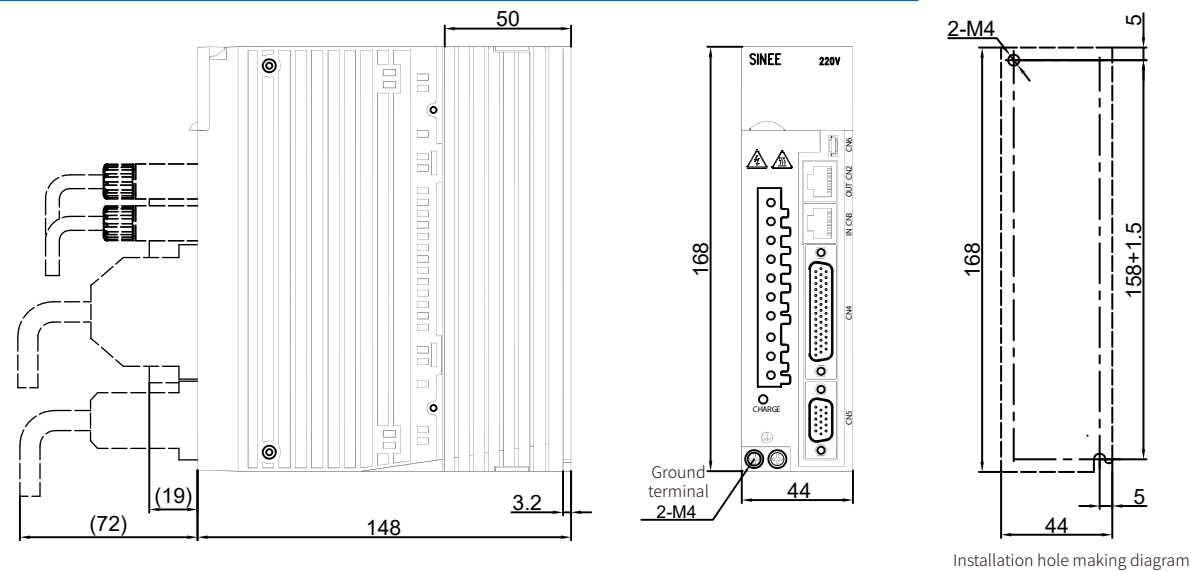

EA180□-0R9-1□ EA180□-1R6-1□ EA180□-2R5-1□

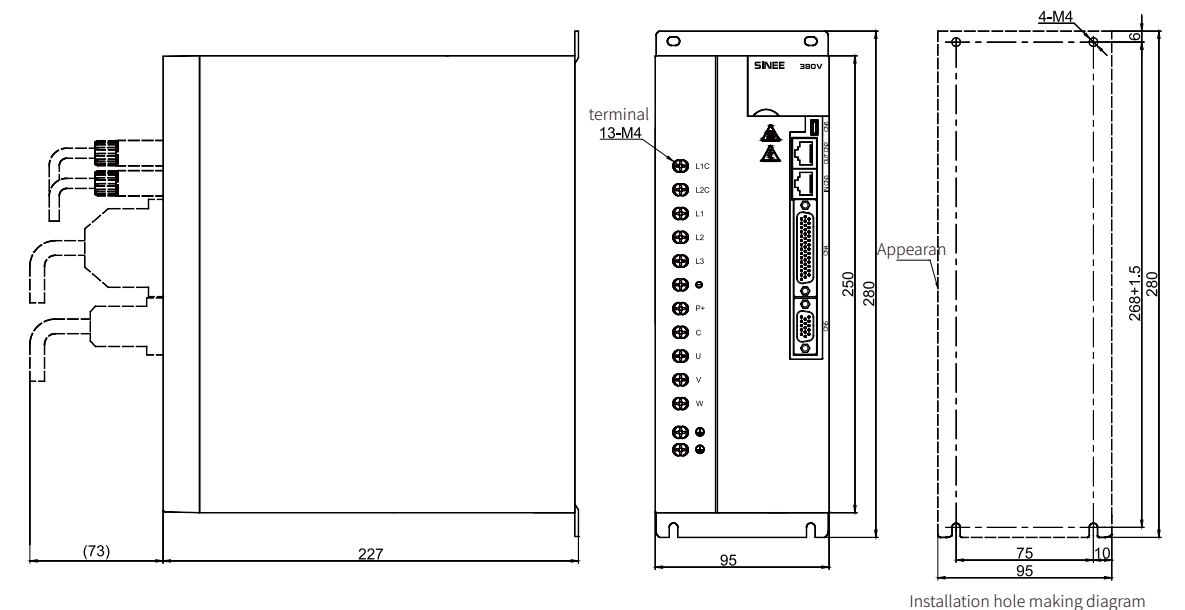

EA180□-017-3□ EA180□-022-3□ EA180□-028-3□

## Technical specification of Series EA180C/P bus servo driver

### EA180C CANopen and EA180P PROFINET bus servo driver

Item		Specification	
Basic specification	Control method	IGBT PWM control sine-wave current drive	
	Feedback	17-bit incremental/encoder, 23-bit absolute encoder	
	Six control modes	Speed control, position control, torque control, speed/position control, torque/speed control, position/torque control	
	Front panel	5 keys, 5-digit LED	
	Regenerative brake	Built-in brake unit and resistor; an external braking resistor can be connected	
	Use conditions	Environment temperature	Working temperature 0~40°, storage temperature -20° ~85°
		Ambient humidity	Working/storage: ≤ 90%RH (without dew condensation)
		Altitude	≤ 1,000m
		Anti-vibration impact strength	Vibration: ≤ 4.9m/s <sup>2</sup> (no operation at the point of resonance is permitted), impact: ≤ 19.6m/s <sup>2</sup>
	Protection level	Protection level	IP10
Pollution level		2 level	
Cooling method	Fan cooling		
Performance	Speed-torque control mode	Speed fluctuation ratio	Load fluctuation: 0~100 load: Maximum 0.3% Supply voltage change: At rated voltage ± 10%: Maximum 0.3% Environment temperature: 0~50°C : Maximum 0.3%
		Speed regulation ratio	1:5000 (17bit and 23bit encoder)
		Frequency bandwidth	1.2kHz (23-bit encoder)
		Torque control accuracy	±3% current repetition accuracy
	Position control mode	Soft start time setting	0~30s (acceleration and deceleration can be set respectively)
		Feedforward compensation	Resolution 0~100% (set resolution 1%)
		Positioning completion width	1~655,335 instruction units (set resolution to 1 instruction unit)
		Min setting time	5ms (no load, from rated speed to positioning completion)
		Speed regulation ratio	Minimal speed/rated rotating speed of continuous stable operation under the rated load
		Based on 23bit encoder, at rated speed	

### EA180 CANopen and EA180P PROFINET bus servo driver

Item		Specification	
EA180C	Input/output signal	Digital input port	8 DI Variable signal distribution Fault reset, position pulse deviation counter clearing, pulse disable, forward drive disable, reverse drive disable, second torque limit, forward inch, backward inch, others
		Digital output	4 DO Variable signal frequency division Servo ready, brake output, motor rotation output, zero-speed signal, speed approach, speed reached, position approach, torque limit, rotating speed limit, warning output, fault output, others
	Built-in function	LED display	Slow down and stop when P-OT and N-OT are valid 5-digit LED display: Main circuit CHARGE
		Protective Function	Over-voltage, under-voltage, over-current, over-speed, IGBT overheat, overload, encoder exception, excessive position error, EEPROM fault, abnormal communication, others
EA180P	Input/output signal	Digital input port	Function allocation available Fault reset, forward drive disable, reverse drive disable, forward inch, backward inch, electronic gear ratio switching etc.
		Digital output	Function allocation available Servo ready, brake output, motor rotation output, zero-speed signal, torque limit, rotating speed limit, warning output, fault output etc.
	Built-in function	Over-travel prevention function	Stopped immediately when P-OT and N-OT are activated.
		Electronic gear ratio	1.0 ≤ B/A ≤ 64000.0
		Protective Function	Over-voltage, under-voltage, over-speed, overheat, overload, over-speed, over-temperature, encoder fault, braking resistor overload fault, EEPROM fault, abnormal communication etc.
		Alarm data tracking function	Record 4 groups of historical alarms and relevant data
Communication function	RS232 communication	Status display, user parameter setting, monitoring display, alarm tracking display, JOG operation and automatic adjustment operation, speed instruction signal etc.	
	Communication mode	RS232, RS485, CANopen Synchronizing cycle: 1ms or its integral multiple	
EA180C	CANopen bus control	The following running modes are supported: Profile Position; Profile Velocity Mode Profile Torque Mode; Homing Mode	

## EA180C/P series servo motor, driver and cable matching table

Servo driver			Motor		
EA180	Model	Supply voltage	Motor	Power	Adaptable motor model
SIZE A	 EA180□-0R9-1 □ EA180□-1R6-1 □ EA180□-2R5-1 □	Single-phase AC220V		50W 100W 200W 400W	SES04-005-30-2FAY □ SES04-0R1-30-2FAY □ SES06-0R2-30-2FBY □ SES06-0R4-30-2FBY □
SIZE B	 EA180□-4R8-2 □ EA180□-6R2-2 □	Single-phase or three-phase AC220V		750W 1000W	SES08-0R7-30-2FBY □ SER13-1R0-10-2FBY □ SER13-1R0-20-2FBY □ SER13-1R0-30-2FBY □
SIZE C	 EA180□-5R6-3 □ EA180□-8R5-3 □ EA180□-013-3 □	Three-phase AC380V		850W 1.3kW 1.8kW	SES13-0R8-15-3FBY □ SES13-1R3-15-3FBY □ SES13-1R8-15-3FBY □
				2.9kW	
SIZE D	 EA180□-011-2 □	Three-phase AC220V		1.5kW 2kW 3kW	SER13-1R5-10-3FBY □ SER13-1R5-20-3FBY □ SER13-1R5-30-3FBY □ SER13-2R0-20-3FBY □ SER13-2R0-30-3FBY □ SER13-3R0-20-3FBY □ SER13-3R0-30-3FBY □
				1.5kW	SER13-1R5-10-2FBY □ SER13-1R5-20-2FBY □ SER13-1R5-30-2FBY □
SIZE E	 EA180□-017-3 □ EA180□-022-3 □ EA180□-028-3 □	Three-phase AV380V		4.4kW 5.5kW 7.5kW	SES18-4R4-15-3FBY □ SES18-5R5-15-3FBY □ SES18-7R5-15-3FBY □



## EA180C/P series servo motor, driver and cable matching table

Motor specification/model	Adaptable driver model	Encoder cable	Motor cable
SER13-1R0-10-2FBY □	EA180 □ -6R2-2B	A10-LS-H100-m (without battery) A10-LA-H100-m (with battery)	A18-LM-H115-m (Power cable for motor without brake)
SER13-1R0-20-2FBY □			A18-LB-H115-m (Power cable for motor with a brake)
SER13-1R0-30-2FBY □			
SER13-1R5-10-2FBY □	EA180 □ -011-2B		
SER13-1R5-20-2FBY □			
SER13-1R5-30-2FBY □			
SER13-1R5-10-3FBY □	EA180 □ -5R6-3B		A18-LM-H120-m (Power cable for motor without brake)
SER13-1R5-20-3FBY □		A18-LB-H120-m (Power cable for motor with a brake)	
SER13-1R5-30-3FBY □			
SER13-2R0-20-3FBY □	EA180 □ -8R5-3B		
SER13-2R0-30-3FBY □			
SER13-3R0-20-3FBY □	EA180 □ -013-3B		
SER13-3R0-30-3FBY □			

Note: When the encoder is used, A10-LA-xxxx-m encoder cable must be selected and used if the absolute position should be memorized upon power off, and A10-LS-xxxx-x encoder cable may be selected and used if the absolute position should be memorized without power off.

Motor specification/model	Adaptable driver model	Encoder cable	Motor cable
SES04-005-30-2FAY □	EA180 □ -0R9-1B	A10-LS-A000-m (without battery) A10-LA-A000-m (with battery)	A18-LM-A007-m (motor power cable)
SES04-0R1-30-2FAY □	EA180 □ -1R6-1B		A10-LZ-A005-m (brake cable for motor with a brake)
SES06-0R2-30-2FBY □	EA180 □ -2R5-1B		
SES06-0R4-30-2FBY □			
SES08-0R7-30-2FBY □	EA180 □ -4R8-2B		
SES08-1R0-30-2FBY □	EA180 □ -6R2-2B		
SES13-0R8-15-2FBY □	EA180 □ -011-2B	A18-LS-H400-m (without battery) A18-LA-H400-m (with battery)	A18-LM-M420-m (motor power cable)
SES13-0R8-15-3FBY □	EA180 □ -5R6-3B		A18-LZ-H405-m (brake cable for motor with a brake)
SES13-1R3-15-3FBY □			
SES13-1R8-15-3FBY □	EA180 □ -8R5-3B		
SES18-2R9-15-3FBY □	EA180 □ -013-3B		Without brake: A18-LM-M525-m (motor power cable)
SES18-3R6-20-3FBY □			With brake: A10-LM-M220-m (motor power cable)
SES18-4R0-30-3FBY □			A18-LZ-H405-m (brake cable for motor with a brake)
SES18-4R4-15-3FBY □	EA180 □ -017-3B		
SES18-5R5-15-3FBY □	EA180 □ -022-3B		A10-LM-M240-m (motor power cable)
SES18-7R5-15-3FBY □	EA180 □ -028-3B		A18-LZ-H405-m (brake cable for motor with a brake)

# EA300E servo driver

Single-phase 220V~240V 0.1~1kW

Three-phase 220V~240V 0.75~1.5kW

Three-phase 340V~460V 1.5~30kW



High-speed response



Bus control



High-precision positioning



Easy to use



## Connection between EA300 EtherCAT bus servo driver and peripheral device

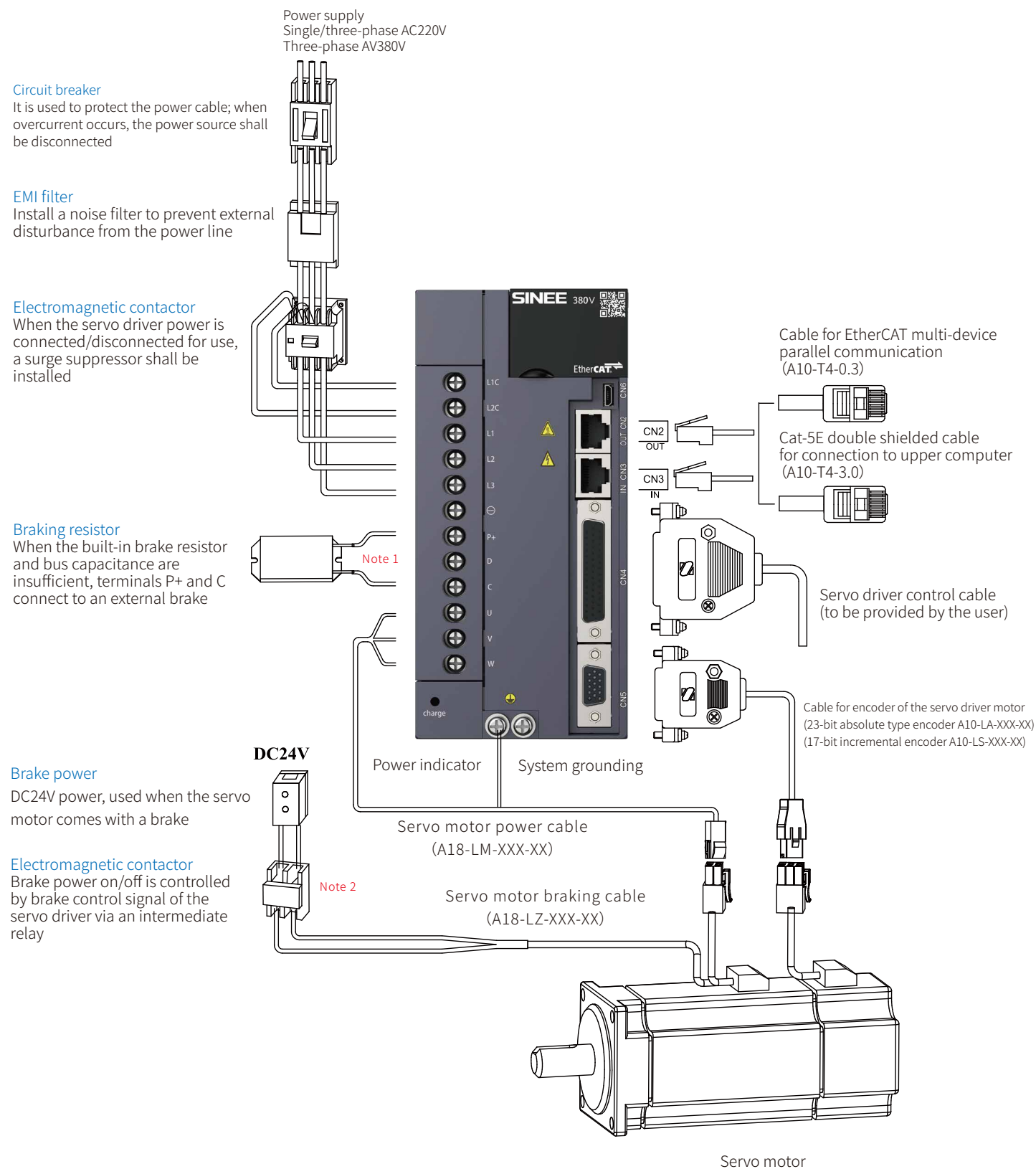

## Terminal description of EA300 Ether CAT bus servo driver

**CN2, CN3 EtherCAT communication**

IN CN3		OUT CN2	
Pin number	Signal name	Pin number	Signal name
1	TD+	1	TD+
2	TD-	2	TD-
3	RD+	3	RD+
4		4	
5		5	
6	RD-	6	RD-
7		7	
8		8	

**CN4 control terminal**

Signal name	Pin number	Default function
DI1	5	P-OT
DI2	20	N-OT
DI3	4	ORPG
DI4	19	ALM-RST
DI5	3	GAIN-SEL
DI6	18	J-SEL
DI7	2	P-CLR
DI8	17	INHIBIT
COM+	21	DI input common positive terminal
COM	7/22/36	Internal 24V power source, voltage range +20V~26V, maximum output current 200mA
DO1	8	S-RDY+
DO1-	37	S-RDY-
DO2	23	BK+
DO2-	38	BK-
DO3	9	COIN+
DO3-	39	COIN-
DO4	24	ALM+
DO4-	10	ALM-

**Main circuit terminal**

Terminal marking	Terminal name
L1C、L2C	Control power input terminal
L1、L2、L3	AC power input terminal of main circuit
P+、D、C	Connecting terminal for an external braking resistor
P+、⊖	Common DC bus terminal
U、V、W	Servo motor connecting terminal
PE	Grounding

**CN5 encoder terminal**

Pin number	Signal name
1	SD+
3	SD-
5	+5V
10	GND
Housing	PE



## Specification of EA300 EtherCAT bus servo driver

Basic specification	Control method		IGBT: PWM control, sine-wave current drive type. 220V, 380V; single phase or three phase full-wave rectifier	
	Encoder feedback		17bit serial incremental encoder, 23bit serial absolute encoder	
	Front panel		5 keys, 5-digit LED display, main power CHARGE	
	Regenerative brake		Can be basically built-in and externally installed	
	Use conditions	Environment temperature	Working temperature 0~40°	
		Ambient humidity	Working/storage: ≤ 90%RH (without dew condensation)	
		Anti-vibration/ impact strength	4.9m/s <sup>2</sup> /19.6m/s <sup>2</sup>	
		Protection level	IP10	
		Pollution level	2 level	
		Altitude	Less than 1,000m	
Cooling method		Fan cooling		
EtherCAT basic specification	Communication protocol		EtherCAT protocol	
	Support services		CoE(PDO, SDO)	
	Instruction synchronization cycle		1ms or its integral multiple	
	Synchronization method		DC- distributed clock	
	Physical layer		100BASE-TX	
	Baud rate		100Mbit/s	
	Duplex mode		Full duplex	
	Topological structure		Linear	
	Transmission medium		Shielded Cat-5E or better network cable	
	Transmission distance		Less than 50m between two nodes	
	Quantity of slave stations		No more than 100	
	EtherCAT frame length		44~1,498 bytes	
	Process data		44~1,498 bytes	
	Communication BER (bit error rate)		1/1000000000	
EtherCAT slave specification	FMMU unit		4	
	Storage synchronization management unit		4	
	Process data RAM		4K	
	Distributed clock		64 digits	
	EEPROM capacity		16K	
	Support running mode CIA402		Profile Position Mode Profile Velocity Mode Profile Torque Mode Interpolation Position Mode Cyclic Synchronous Position Mode Cyclic Synchronous Velocity Mode Cyclic Synchronous Torque Mode Homing Mode	
Performance	Speed-torque control mode	Speed fluctuation ratio	Load fluctuation	At 0~100% load: Maximum 0.3%
			Supply voltage change	At rated voltage ± 10%: Maximum 0.3%
			Environment temperature	0~50°C : Maximum 0.3%
		Speed regulation ratio	1:5000	Minimal speed/rated rotating speed of continuous stable operation under the rated load
		Frequency bandwidth	1.0KHz (17bit and 23bit encoder)	
	Position control mode	Torque control accuracy	±3% (current repetition accuracy)	
		Soft start time setting	0~30s (acceleration and deceleration can be set respectively)	
		Feedforward compensation	Resolution 0~100% (set resolution 1%)	
	Input/output signal	Digital input signal	Function allocation available	
		Digital output signal	Function allocation available	
Built-in function	Over-travel (OT) prevention function		Stopped immediately when P-OT and N-OT are activated.	
	Electronic gear ratio		1.0 ≤ B/A ≤ 64000.0	
	Protective Function		Over-voltage, under-voltage, over-speed, overheat, overload, over-speed, over-temperature, encoder alarm, braking resistor overload alarm, excessive position error, EEPROM alarm, abnormal communication etc.	
	RS232 communication		Status display, user parameter setting, monitoring display, alarm tracking display, JOG operation and automatic tuning operation, speed, torque instruction signal etc.	
Others		Gain adjustment, alarm record, JOG operation		

## EA300E series servo motor, driver and cable matching table

		Servo driver		Motor		
	EA300E	Model	Supply voltage	Motor	Power	Adaptable motor model
SIZE A		EA300E-0R9-1B EA300E-1R6-1B EA300E-2R5-1B	Single-phase AC220V		50W 100W 200W 400W	SES04-005-30-2FAY □ SES04-0R1-30-2FAY □ SES06-0R2-30-2FBY □ SES06-0R4-30-2FBY □
SIZE B		EA300E-4R8-2B EA300E-6R2-2B	Single-phase or three-phase AC220V		750W 1000W	SES08-0R7-30-2FBY □ SES08-1R0-30-2FBY □ SES13-1R1-20-2FBY □
SIZE C		EA300E-5R6-3B EA300E-8R5-3B EA300E-013-3B	Three-phase AC380V		850W 1.3kW 1.7kW	SES13-0R8-15-3FBY □ SES13-1R3-15-3FBY □ SES13-1R7-30-3FBY □ SES13-1R1-20-3FBY □ SES13-1R7-20-3FBY □
					1.8kW 2.4kW 2.6kW 2.9kW 3.6kW	SES13-2R6-30-3FBY □ SES13-1R8-15-3FBY □ SES13-2R4-20-3FBY □ SES13-3R6-30-3FBY □ SES18-2R9-15-3FBY □
SIZE C		EA300E-011-2B	Three-phase AC220V		0.8kW 1.1kW 1.7kW	SES13-1R1-20-2FBY □ SES13-0R8-15-2FBY □ SES13-1R7-30-2FBY □
SIZE D		EA300E-017-3B EA300E-022-3B EA300E-028-3B	Three-phase AC380V		4.4kW 5.5kW 7.5kW	SES18-4R4-15-3FBY □ SES18-5R5-15-3FBY □ SES18-7R5-15-3FBY □
					11kW 13kW 15kW	SEC20-011-15-3FBY □ SEC20-011-20-3FBY □ SEC20-013-15-3FBY □ SEC20-015-15-3FBY □ SEC23-011-15-3FBY □
SIZE E		EA300E-038-3B EA300E-052-3B EA300E-062-3B	Three-phase AC380V		15kW 18kW 22kW 29kW	SEC23-015-15-3FBY □ SEC23-018-15-3FBY □ SEC23-022-15-3FBY □ SEC23-029-15-3FBY □

# EA190 servo driver

Single-phase 220V~240V 0.1~1kW

 Stable and reliable

 Bus control

 High-precision positioning

 Easy to use



## Connection between Series EA190E bus servo driver and peripheral device

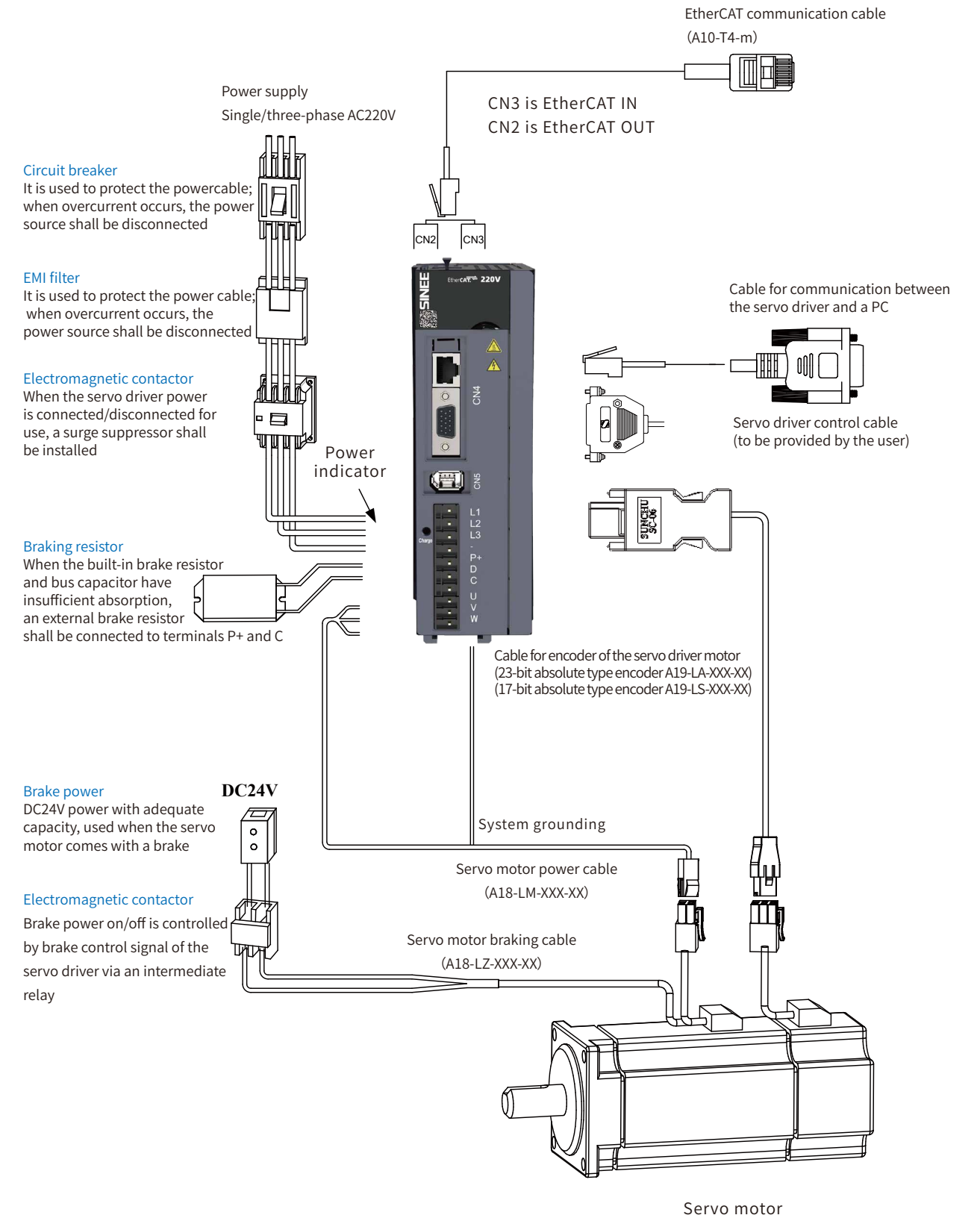



## Model description of EA190E bus servo driver

EA 190 X - 6R2 - 2 B - XX  
 ① ② ③ ④ ⑤ ⑥ ⑦

① Product Servo driver	④ Rated output current 0R9-0.9A 6R2-6.2A	⑥ Encoder type B: 17/23-bit serial encoder
② Series 190 series		
③ Null: Pulse type E: EtherCAT bus type	⑤ Power voltage specification 1. Single-phase 220V 2. Single/three-phase 220V	⑦ Special specifications

## Dimension diagram of EA190E bus servo driver

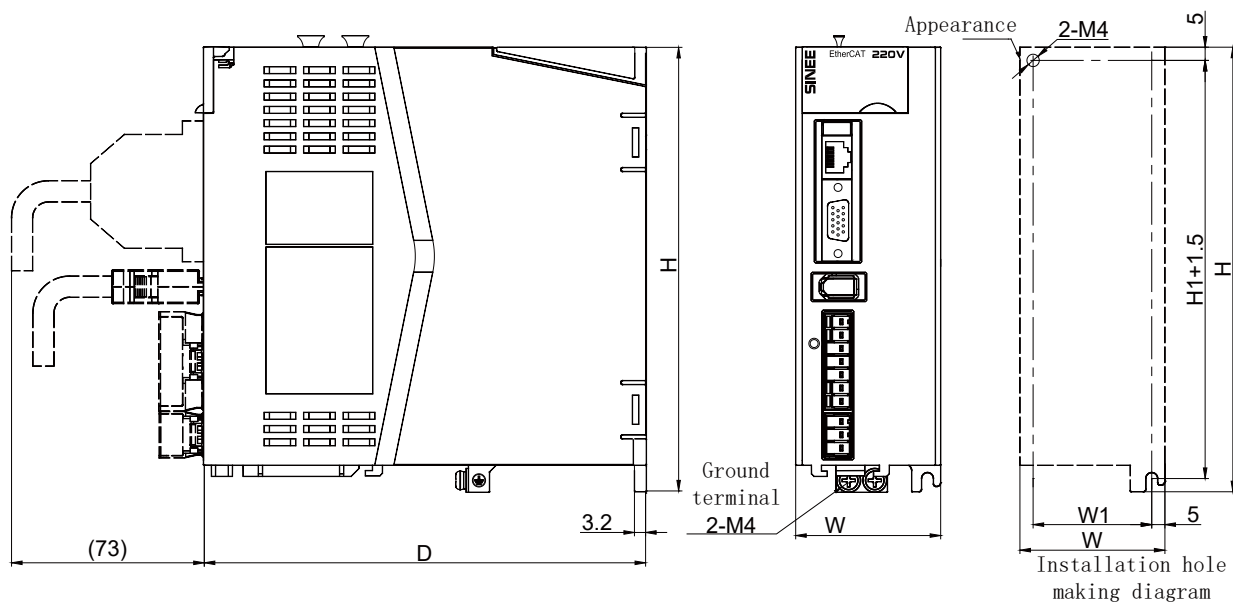



Model	D	H	W	W1	H1
EA190E-0R9-1B EA190E-1R6-1B EA190E-2R5-1B	150	168	44	34	158
EA190E-4R8-2B EA190E-6R2-2B	168	168	55	45	158

## Specification of Series EA190E bus servo driver

Basic specification	Control method	IGBT: PWM control, sine-wave current drive type		
	Front panel	5 keys, 5-digit LED display, main power CHARGE		
	Regenerative brake	Can be basically built-in and externally installed		
	Use conditions	Environment temperature	Working temperature 0~40°	
		Ambient humidity	Working/storage: ≤ 90%RH (without dew condensation)	
		Anti-vibration/ impact strength	4.9m/s <sup>2</sup> /19.6m/s <sup>2</sup>	
		Protection level	IP20	
		Pollution level	2 level	
		Altitude	Less than 1,000m	
	Cooling method	Natural (specifications 0R9, 1R6, 2R5)/ fan cooling (specifications 4R8, 6R2)		
EtherCAT basic specification	Communication protocol	EtherCAT protocol		
	Support services	CoE(PDO, SDO)		
	Instruction synchronization cycle	1ms or its integral multiple		
	Synchronization method	DC- distributed clock		
	Physical layer	100BASE-TX		
	Baud rate	100Mbit/s		
	Duplex mode	Full duplex		
	Topological structure	Linear		
	Transmission medium	Shielded Cat-5E or better network cable		
	Transmission distance	Less than 50m between two nodes		
	Quantity of slave stations	No more than 100		
	EtherCAT frame length	44~1,498 bytes		
	Process data	44~1,498 bytes		
	Communication BER (bit error rate)	1/1000000000		
EtherCAT slave specification	FMMU unit	4		
	Storage synchronization management unit	4		
	Process data RAM	4K		
	Distributed clock	64 digits		
EtherCAT configuration unit	EEPROM capacity	16K		
	Support running mode CIA402	Profile Position Mode Profile Velocity Mode Profile Torque Mode Interpolation Position Mode Cyclic Synchronous Position Mode Cyclic Synchronous Velocity Mode Cyclic Synchronous Torque Mode Homing Mode		
Speed-torque control mode	Speed fluctuation ratio	Load fluctuation	At 0~100% load: Maximum 0.3%	
		Supply voltage change	At rated voltage ± 10%: Maximum 0.3%	
		Environment temperature	0~50°C : Maximum 0.3%	
	Speed regulation ratio	1:5000	At rated speed	
Position control mode	Frequency bandwidth	1.0KHz (17bit and 23bit encoder)		
	Torque control accuracy	± 3% (current repetition accuracy)		
	Soft start time setting	0~30s (acceleration and deceleration can be set respectively)		
Digital input signal	Function allocation available	Feedforward compensation	Resolution 0~100% (set resolution 1%)	
		Positioning completion width	1~655,335 instruction units (set resolution to 1 instruction unit)	
		Min setting time	5ms (no load, from rated speed to positioning completion)	
Digital output signal	Function allocation available	Servo enable, alarm resetting, pulse deviation counter clearing, speed command direction selection, position/speed multi-segment switching, internal command trigger, control mode switching, forward drive disable, reverse drive disable, forward inch, backward inch		
		Servo ready, brake output, motor rotation output, zero-speed signal, speed approach, speed reached, position approach, torque limit, rotating speed limit, warning output, alarm output		
		Over-travel (OT) prevention function		
Electronic gear ratio		1.0 ≤ B/A ≤ 64000.0		
Protective Function		Over-voltage, under-voltage, over-speed, overheat, overload, over-speed, over-temperature, encoder alarm, braking resistor overload alarm, excessive position error, EEPROM alarm, abnormal communication etc.		
RS232 communication		Status display, user parameter setting, monitoring display, alarm tracking display, JOG operation and automatic tuning operation, speed, torque instruction signal etc.		
Others		Gain adjustment, alarm record, JOG operation		

## EA190E series servo motor and driver matching table

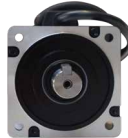
Servo driver			Motor		
EA190	Model	Supply voltage	Motor	Power	Adaptable motor model
SIZE A	 EA190E-0R9-1B EA190E-1R6-1B EA190E-2R5-1B	Single-phase AC220V		50W 100W 200W 400W	SES04-005-30-2HAY □ SES04-0R1-30-2HAY □ SES06-0R2-30-2HBY □ SES06-0R4-30-2HBY □
					
SIZE B	 EA190E-4R8-2B EA190E-6R2-2B	Single-phase or three-phase AC220V		750W 1000W	SES08-0R7-30-2HBY □ SES08-1R0-30-2HBY □ SER13-1R0-10-2HBY □ SER13-1R0-20-2HBY □ SER13-1R0-30-2HBY □ SES13-1R1-20-2HBY □

## EA190E series servo motor and driver matching table

Motor specification/model	Adaptable driver model	Encoder cable	Motor cable
SES04-005-30-2HAY □	EA190□-0R9-1B	A19-LS-A000-m (without battery) A19-LA-A000-m (with battery)	A18-LM-A007-m (motor power cable) A18-LZ-A005-m (brake cable for motor with a brake)
SES04-0R1-30-2HAY □	EA190□-1R6-1B		
SES06-0R2-30-2HBY □	EA190□-2R5-1B		
SES06-0R4-30-2HBY □	EA190□-4R8-2B		
SES08-0R7-30-2HBY □	EA190□-6R2-2B		
SES08-1R0-30-2HBY □	EA190□-6R2-2B	A19-LS-H100-m (without battery) A19-LA-H100-m (with battery)	Without brake: A18-LM-H115-m With brake: A18-LB-H115-m
SER13-1R0-10-2HBY □			
SER13-1R0-20-2HBY □			
SER13-1R0-30-2HBY □			





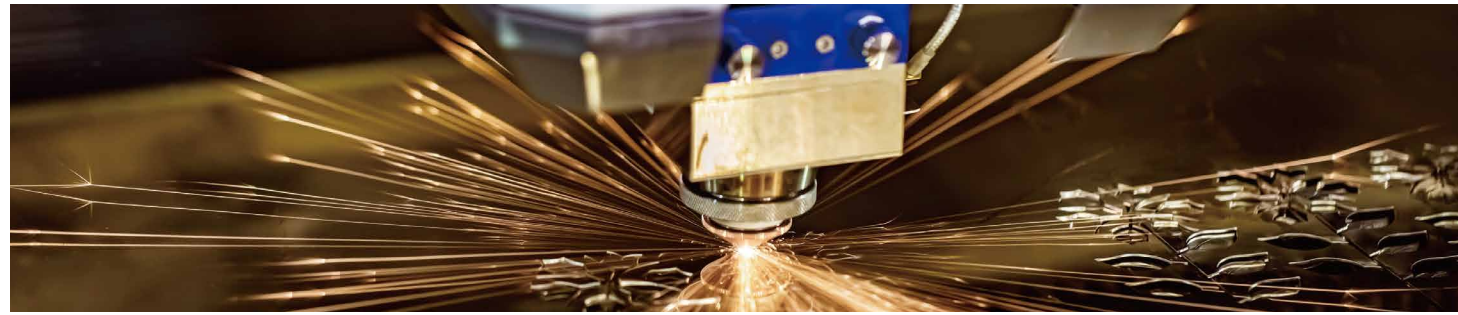

## Model description of SER/SES series servo motor

SES 08 - 0R7-30-2 F B Y 1 -XX  
 ① ② ③ ④ ⑤ ⑥ ⑦ ⑧ ⑨ ⑩

① series	② flange size of the motor	③ rated output power of the motor
SER: Standard servo motor SES: High-performance servo motor	04: 40mm 06: 60mm 08: 80mm 09: 86mm 11: 110mm 13: 130mm 18: 180mm 20: 200mm	005: 50W 0R1: 100W 0R2: 200W 0R4: 400W 0R7: 750W 1R0: 1000W 1R5: 1500W 2R0: 2000W 3R0: 3000W 4R4: 4400W 5R5: 5500W 7R5: 7500W
④ rated speed of the motor	⑦ inertia type	⑨ optional accessory
10: 1000rpm 15: 1500rpm 20: 2000rpm 25: 2500rpm 30: 3000rpm	A: Low inertia B: Medium inertia C: High inertia	Null: No optional accessory 1: With holding brake (DC24V) 2: With oil seal 3: With holding brake and oil seal 4: With fans 5: With brake and fans
⑤ voltage level	⑧ bit Shaft end	⑩ special specification
2: 220V 3: 380V	X: Optical axis, without key slot <sup>*1</sup> Y: Y: With U-shaped key slot and screw hole <sup>*2</sup> Z: With double-circular key slot and screw hole	
⑥ encoder type		
A: 2500ppr incremental encoder B: 17bit incremental encode H: 17bit incremental magnetic encoder F: 23bit absolute type encoder K: 17bit absolute type magnetic encoder		

Note 1: Generally not provided. Can be used as optical axis when the key is taken off.

Note 2: Partial varieties can be of double-circular key slots; except for motors with flange 130, the key width and height are the same with the U-shaped key slots.

Note 3: Random combination of various elements above is not available.

## Common features of SER/SES series servo motors

Motor insulation level	FClass
Withstand voltage of insulation	1500V 60s
Insulation resistance	DC500V, above 10MΩ
Thermal resistance level of the motor	B
Protection level	Fully-closed self-cooling type, IP65 (except for the shaft running-through part)
Service environment	Ambient temperature 0-40°, RH 20%~80% (without dew condensation)
Installation method	Flange installation
Rotation direction	Rotate counterclockwise (CCW) under a forward command if viewed from the load side

## Holding brake specification

Motor flange size	Rated torque of motor	Rated voltage	Static friction torque	Rated power	Closing voltage	Release voltage	Set the closing action time	Set the release action time
mm	Nm	VDC	Nm	W	VDC	VDC	ms	ms
40	0.32 ≤	24	0.35	3.5	22	1.5	63	55
60	0.64~1.27		2	6.3				
80	1.3~3.5		4	10.4				
86	3.2~3.5		4	10.4				
110	2~6		10	11.6				
130	3.2~15		20	19.5				
180	17~35		44	25				
180	≥ 36		74	45				
200	35~95.5		120	95				
230	70~184		200	120				
							87	72
							110	95
							140	120
							152	130
							165	140
							230	180

1: The holding brake is used to keep the motor locked after stop, and cannot be used for braking.

2: A 24V power source shall be provided by the user for the holding brake, and it is prohibited to connect the holding brake to the 24V power in the servo driver. The 24V power source shall have a capacity that is at least 1.5 times the rated power of the holding brake (excluding capacity of any 24V power source for other devices).

3: The action time of the holding brake may differ for different circuits. The time provided above is only for reference, and the actual time depends on the physical product.

4: Static friction torque refers to the static friction torque provided by the brake when the motor is static; if there is external impact, keeping the motor static cannot be assured.



## Installation dimension of SER series servo motor

- Dimensions of SER series servo motors with flanges 110 and 130

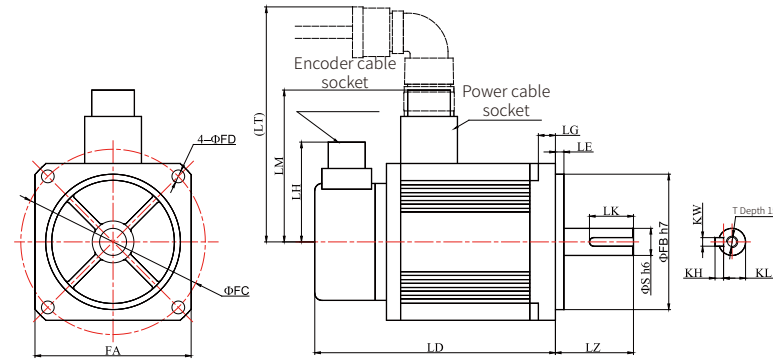

Motor specification/model	LD (mm)	FA (mm)	FB (mm)	FC (mm)	FD (mm)	LZ (mm)	LK (mm)	LE (mm)	LG (mm)	LH (mm)	LM (mm)	LT (mm)	S (mm)	KL (mm)	KH (mm)	KW (mm)	T (mm)	Weight (kg)	Cable connector model
SER11-1R0-20-2 □ B □ □	205.5 (260.5)	110	95	130	9	55	31	6	9	-	107	176	19	15.5	6	6	M6	6.42 (7.88)	Without brake: Aviation plug YD28K4T With brake: Aviation plug YD28K7T Aviation plug YD28K15TS
SER11-1R2-30-2 □ B □ □	185.5 (240.5)	110	95	130	9	55	31	6	9	-	107	176	19	15.5	6	6	M6	5.46 (6.92)	
SER11-1R8-30-2 □ B □ □	218.5 (273.5)	110	95	130	9	55	31	6	9	-	107	176	19	15.5	6	6	M6	7.26 (8.72)	
SER13-1R0-10-2 □ B □ □	215 (270)	130	110	145	9	58	45	6	12	-	117	186	22	18	7	8	M6	10.12 (11.67)	
SER13-1R0-20-2 □ B □ □	165 (220)	130	110	145	9	58	45	6	12	-	117	186	22	18	7	8	M6	6.41 (7.94)	
SER13-1R0-30-2 □ B □ □	150 (205)	130	110	145	9	58	45	6	12	-	117	186	22	18	7	8	M6	5.31 (6.89)	
SER13-1R5-10- □ □ B □ □	265 (320)	130	110	145	9	58	45	6	12	-	117	186	22	18	7	8	M6	13.82 (15.40)	
SER13-1R5-20- □ □ B □ □	185 (240)	130	110	145	9	58	45	6	12	-	117	186	22	18	7	8	M6	7.89 (9.43)	
SER13-1R5-30- □ □ B □ □	165 (220)	130	110	145	9	58	45	6	12	-	117	186	22	18	7	8	M6	6.40 (7.96)	
SER13-2R0-20-3 □ B □ □	215 (270)	130	110	145	9	58	45	6	12	-	117	186	22	18	7	8	M6	10.12 (11.67)	
SER13-2R0-30-3 □ B □ □	185 (240)	130	110	145	9	58	45	6	12	-	117	186	22	18	7	8	M6	7.85 (9.47)	
SER13-3R0-20-3 □ B □ □	265 (320)	130	110	145	9	58	45	6	12	-	117	186	22	18	7	8	M6	13.81 (15.34)	
SER13-3R0-30-3 □ B □ □	215 (270)	130	110	145	9	58	45	6	12	-	117	186	22	18	7	8	M6	10.12 (11.67)	



## Installation dimension of SES series servo motor

- Dimensions of SES series servo motors with flanges 40, 60 and 80

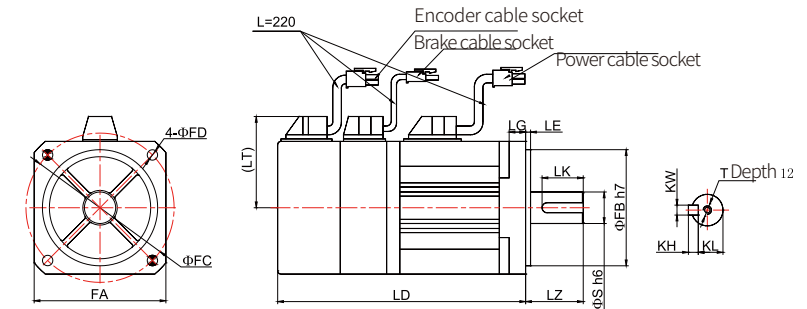

Motor specification/model	LD (mm)	FA (mm)	FB (mm)	FC (mm)	FD (mm)	LZ (mm)	LK (mm)	LE (mm)	LG (mm)	LT (mm)	S (mm)	KL (mm)	KH (mm)	KW (mm)	T (mm)	Weight (kg)	Cable connector model
SES04-005-30-2 □ AY □	85 (119.5)	40	30	46	4.5	25.5	14	3	8	37	8	6.3	3	3	M3	0.4 (0.6)	Power side: 172159-1 Brake side: 172157-1 Reed: 170362-1 Encoder side: 172161-1 Reed: 170361-1
SES04-0R1-30-2 □ AY □	100 (133.5)	40	30	46	4.5	25.5	14	3	8	37	8	6.3	3	3	M3	0.47 (0.67)	
SES06-0R2-30-2 □ BY □	93.7 (120.2)	60	50	70	4.5	30	20	3	8	48	14	8.5	4	4	M5	1.01 (1.4)	
SES06-0R4-30-2 □ BY □	110.7 (137.2)	60	50	70	4.5	30	25	3	8	48	14	11	5	5	M5	1.37 (1.78)	
SES08-0R7-30-2 □ BY □	122.4 (150.6)	80	70	90	6.3	35	25	3	10	58	19	15.5	6	6	M5	2.4 (2.8)	
SES08-1R0-30-2 □ BY □	136.4 (164.6)	80	70	90	6.3	35	25	3	10	58	19	15.5	6	6	M5	3.0 (3.4)	

Note: An SES04 motor has two installation holes at the two shadowed locations as shown in the figure

- Dimensions of SES series servo motors with flanges 130 and 180

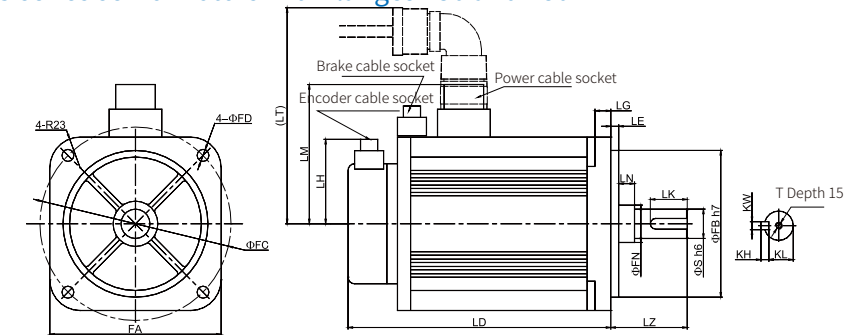

Motor specification/model	LD (mm)	FA (mm)	FB (mm)	FC (mm)	FD (mm)	LZ (mm)	LK (mm)	LE (mm)	LG (mm)	LH (mm)	LM (mm)	LN (mm)	FN (mm)	S (mm)	KL (mm)	KH (mm)	KW (mm)	T (mm)	Weight (kg)	Cable connector model	
SES13-0R8-15-3FBY □	150.9 (183.4)	130	110	145	9	58	27.5	6	12	63.3	105	230	12	28	19	16	5	5	M5	5.83 (17.8)	Power side: MS108A18-10S Brake side: SM10-SP25-ST-V
SES13-1R7-30-3FBY □	166.9 (199.4)	130	110	145	9	58	28	6	12	63.3	105	230	12	28	22	18.5	6	6	M5	7.25 (9.3)	
SES13-1R3-15-3FBY □	184.9 (217.4)	130	110	145	9	58	29	6	12	63.3	105	230	12	28	24	20	8	8	M5	8.8 (10.8)	
SES18-2R9-15-3FBY □	173.3 (231)	180	114.3	200	13.5	79	65	3.2	18	63.3	135.5	230	0	35	35	30	8	10	M12	13 (19.5)	Power side: MS108A22-2S Brake side: SM10-SP25-ST-V Encoder side: SM10-SP105-M1-T-V
SES18-3R6-20-3FBY □	197.3 (324)	180	114.3	200	13.5	79	65	3.2	18	63.3	135.5	230	0	35	35	30	8	10	M12	17.5 (24)	
SES18-4R4-15-3FBY □	197.3 (324)	180	114.3	200	13.5	79	65	3.2	18	63.3	135.5	230	0	35	35	30	8	10	M12	17.5 (24)	
SES18-5R5-15-3FBY □	236.3 (278)	180	114.3	200	13.5	113	96	3.2	18	114.3	145.5	230	0	42	42	37	10	12	M16	22 (27.8)	
SES18-7R5-15-3FBY □	282.3 (324)	180	114.3	200	13.5	113	96	3.2	18	114.3	145.5	230	0	42	42	37	10	12	M16	29.5 (35)	

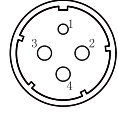
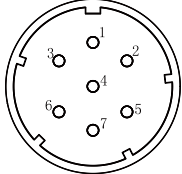
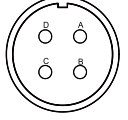

## Pin distribution of the motor-side power terminal

Connector type	Pin distribution	Pin number	Function definition
TE 172159-1		1	U
		2	V
		3	W
		4	PE
YD28K4TS The diameter of contact pairs is 3*φ3.5mm +1*φ2.5mm		1	PE
		2	U
		3	V
		4	W
The diameter of YD28K7TS contact pairs is 7*φ2.5mm		1	PE
		2	U
		3	V
		4	W
		5	24V (brake)
		6	0V (brake)
		7	Null
MS3105A18-10S MS3108A22-22S MS3105A32-17S		A	U
		B	V
		C	W
		D	PE

### • Pin distribution of the motor-side encoder terminal

Connector type	TE 172163-1		TE 172161-1		YD28K15TS		CM10-SP10S-MD	
	Signal	Pin number	Signal	Pin number	Signal	Pin number	Signal	Pin number
2500ppr incremental encoder	A+	9	V+	10	A+	4	V+	11
	A-	13	V-	12	A-	7	V-	14
	B+	4	W+	11	B+	5	W+	12
	B-	14	W-	15	B-	8	W-	15
	Z+	7	+5V	2	Z+	6	+5V	2
	Z-	5	GND	3	Z-	9	GND	3
	U+	6	PE	1	U+	10	PE	1
17/23-bit encoder	U-	8			U-	13		
	+5V	1	+5V	2	+5V	2	+5V	4
	GND	2	GND	3	GND	3	GND	9
	SD+	5	SD+	4	SD+	4	SD+	1
	SD-	6	SD-	7	SD-	7	SD-	2
VD+	3	VD+	14	VD+	6	VD+	6	
VD-	4	VD-	15	VD-	5	VD-	5	
PE	9	PE	1	PE	1	PE	10	

## Torque-speed characteristic curve of Series SER/SES servo motors

### • Torque-speed characteristic curve of 40, 60 & 80 servo motors with flanges

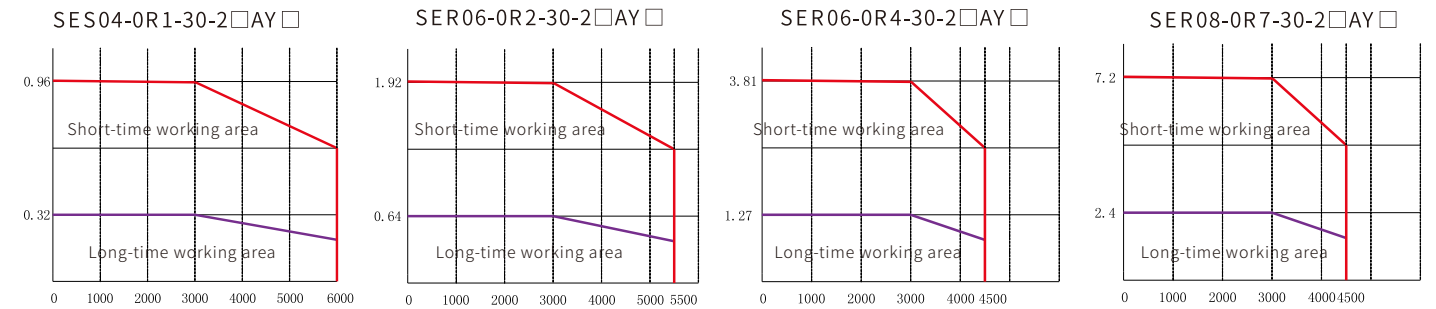

### • Torque-speed characteristic curve of 130 servo motors with flanges

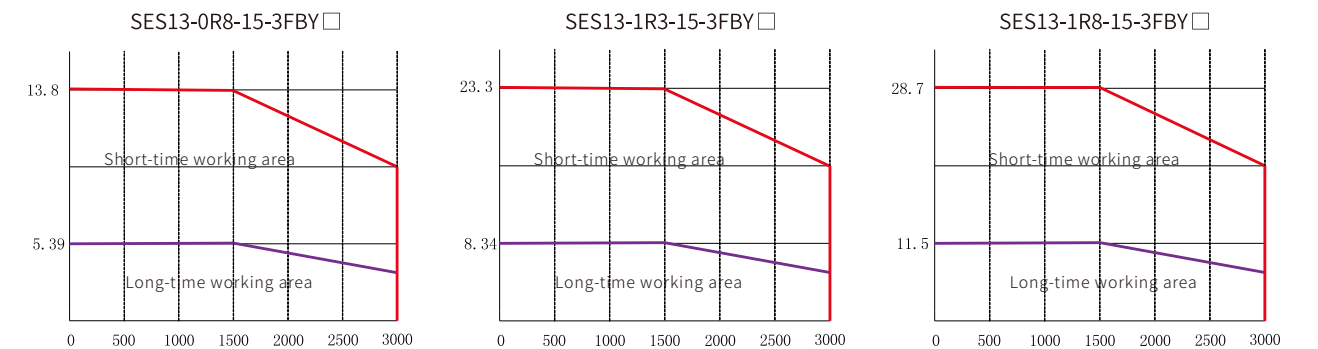
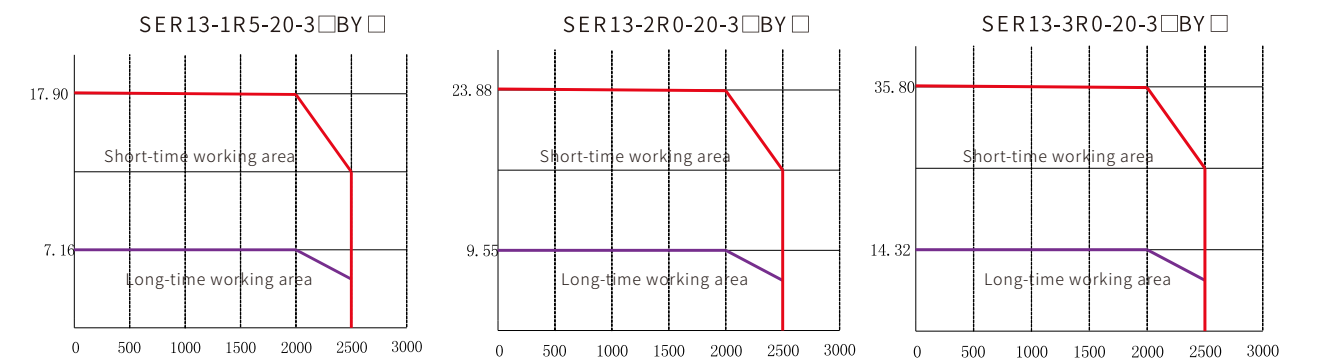

### • Torque-speed characteristic curve of 180 servo motors with flanges

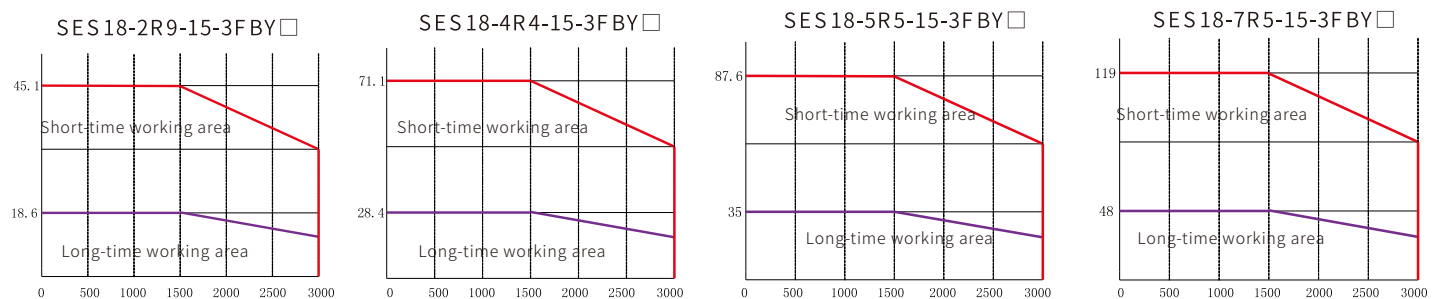



 **Parameter table of SER series servo motor**

Servo motor model	Voltage class V	Rated power W	Rated rotating speed rpm	Maximum rotating speed rpm	Rated current A	Maximum instantaneous current A	Rated torque Nm	Maximum instantaneous torque Nm	Torque constant Nm/A	Rotating inertia Kg.cm <sup>2</sup> *10 <sup>-4</sup>	Adaptable driver
SER11-1R0-20-2 □ BY □	AC220V	1000	2000	2500	5.0	15.0	5.0	15.00	1.0	7.22(7.24)	6R2-2 □
SER11-1R2-30-2 □ BY □											
SER11-1R8-30-2 □ BY □		1200	3000	3500	4.9	14.7	4.0	12.00	0.82	5.54(5.56)	011-2 □
SER13-1R0-10-2 □ BY □		1800	3000	3500	6.6	19.8	6.0	18.00	0.91	8.55(8.57)	
SER13-1R0-20-2 □ BY □		1000	2000	2500	4.72	14.2	4.77	14.31	1.01	8.71(8.73)	6R2-2 □
SER13-1R0-30-2 □ BY □											
SER13-1R5-10-3 □ BY □											
SER13-1R5-20-3 □ BY □		1000	1500	5.4	13.5	14.32	35.80	2.65	25.58(25.6)		
SER13-1R5-30-3 □ BY □		AC 380	2000	2500	6.5	16.3	9.55	23.88	1.47	17.14(17.16)	8R5-3 □
SER13-2R0-20-3 □ BY □											
SER13-2R0-30-3 □ BY □	3000		3500	5.8	14.5	6.5	16.25	1.12	12.08(12.1)	013-3 □	
SER13-3R0-20-3 □ BY □	2000		2500	9.6	24.0	14.32	35.80	1.49	25.58(25.6)		
SER13-3R0-30-3 □ BY □	3000	3500	8.3	20.8	9.55	23.88	1.15	17.14(17.16)			

Note 1: Value in () is the value in case a brake is provided;  
 2: When an oil seal is provided, it shall be derated by 10% for use

 **Parameter table of SES series servo motor**

Servo motor model	Voltage class V	Rated power W	Rated rotating speed rpm	Maximum rotating speed rpm	Rated current A	Maximum instantaneous current A	Rated torque Nm	Maximum instantaneous torque Nm	Torque constant Nm/A	Rotating inertia Kg.cm <sup>2</sup> *10 <sup>-4</sup>	Adaptable driver EA180-
SES04-005-30-2 □ AY □	AC 220	50	3000	6000	0.6	1.8	0.16	0.48	0.26	0.02(0.02)	0R9-1 □
SES04-0R1-30-2 □ AY □		100	3000	6000	1.1	3.3	0.32	0.96	0.29	0.04(0.04)	1R6-1 □
SES06-0R2-30-2 □ BY □		200	3000	6000	1.6	4.8	0.64	1.92	0.44	0.29(0.34)	1R6-1 □
SES06-0R4-30-2 □ BY □											
SES08-0R7-30-2 □ BY □		400	3000	6000	2.3	6.9	1.27	3.81	0.59	0.56(0.61)	2R5-1 □
SES08-1R0-30-2 □ BY □											
SES08-1R0-30-2 □ BY □		750	3000	5000	4.0	12	2.4	7.2	0.653	1.56(1.66)	4R8-2 □
SES13-0R8-15-2FBY □											
SES13-1R1-20-2 □ BY □		1000	3000	5000	6.0	18	3.2	9.6	0.538	2.03(2.13)	6R2-2 □
SES13-1R7-30-2 □ BY □											
SES13-0R8-15-3FBY □		850	1500	3000	6.9	17	5.39	13.8	1.72	13.95(16.1)	011-2B
SES13-1R1-20-3 □ BY □											
SES13-1R3-15-3FBY □		1100	2000	4000	7.2	18.9	5.39	14.15	0.75	13.95(16.1)	011-2B
SES13-1R7-30-3 □ BY □											
SES13-1R7-30-3 □ BY □		1700	3000	5000	9.2	24.1	5.39	14.15	0.69	13.95(16.1)	011-2B
SES13-1R7-30-3 □ BY □											
SES13-1R7-30-3 □ BY □	850	1500	3000	3.5	8.5	5.39	13.8	1.72	13.95(16.1)	5R6-3B	
SES13-1R7-30-3 □ BY □											
SES13-1R7-30-3 □ BY □	1700	3000	5000	5.3	13.9	5.39	14.15	1.02	13.95(16.1)	5R6-3B	
SES13-1R1-20-3 □ BY □											
SES13-1R3-15-3FBY □	1100	2000	4000	4.3	11.3	5.39	14.15	1.25	13.95(16.1)	5R6-3B	
SES13-1R7-30-3 □ BY □											
SES13-1R7-30-3 □ BY □	1300	1500	3000	5.4	14	8.34	23.3	1.78	19.95(22.1)	5R6-3B	
SES13-1R7-30-3 □ BY □											
SES13-1R7-30-3 □ BY □	1700	2000	4000	7.5	22.5	8.34	25	1.11	19.95(22.1)	8R5-3B	
SES13-2R6-30-3 □ BY □											
SES13-1R8-15-3FBY □	2600	3000	5000	8	22.35	8.34	23.3	1.04	19.95(22.1)	8R5-3B	
SES13-2R4-20-3 □ BY □											
SES13-3R6-30-3 □ BY □	1800	1500	3000	8.4	20	11.5	28.7	1.5	26.1(28.1)	8R5-3B	
SES13-2R4-20-3 □ BY □											
SES13-3R6-30-3 □ BY □	2400	2000	4000	8.9	22.2	11.5	28.7	1.29	26.1(28.1)	013-3B	
SES18-2R9-15-3FBY □											
SES18-4R4-15-3FBY □	3600	3000	5000	10.8	27	11.5	28.7	1.07	26.1(28.1)	013-3B	
SES18-5R5-15-3FBY □											
SES18-7R5-15-3FBY □	2900	1500	3000	11.9	28	18.6	45.1	1.7	46.0(53.9)	013-3B	
SES18-3R6-20-3FBY □											
SES18-4R4-15-3FBY □	4400	1500	3000	16.5	40.5	28.4	71.1	1.93	67.5(75.4)	017-3B	
SES18-5R5-15-3FBY □											
SES18-5R5-15-3FBY □	5500	1500	3000	20.8	52	35	87.6	1.8	89.0(96.9)	022-3B	
SES18-7R5-15-3FBY □											
SES18-7R5-15-3FBY □	7500	1500	3000	25.7	65	48	119	1.92	125.0(133)	028-3B	
SES18-3R6-20-3FBY □											
SES18-3R6-20-3FBY □	3600	2000	2500	9.5	28.5	16.7	50.16	2.1	46.0(53.9)	013-3B	

Note: 1: Value in () is the value in case a brake is provided;



# CNC machine tool

## ◎ Industrial demand

Machines and equipment have become a part of human production and life. Where machines and equipment are used, machine tools are needed. Machine tools can machine parts with high precision and surface roughness requirements by casting, forging, welding, pressing, extruding or otherwise for manufacture of equipment. Manufacturing is a pillar industry for economic development of a country. Strength of the machine tool industry is one of the key indicators that reflect the manufacturing development level of the country. CNC machines tools have become a mainstream development trend of modern machine tools due to their high precision, good flexibility, high work efficiency, compound functions, intelligent control and other features.

## ◎ Highlights of the scheme

- Adaptable to multiple motor types
- Different types of interfaces for connection to CNC systems of different brands
- Accommodated to multiple types of machining processes: 6,000~24,000 r high-speed precision machining, C-axis function, low-speed heavy cutting machining, rigid tapping, independent positioning function, spindle swing function

## ◎ Scheme composition

- Multi-axis synchronous control approach
- Electric screw press approach





# Semiconductor, silicon wafer machining

## © Industrial demand

Multi wire cutting is a new cutting method that can cut semiconductor or other hard and brittle materials (such as silicon plate, sapphire, ruby, neodymium iron boron, ferrite and so on) into several hundred of thin sheets at a time by high-speed reciprocating movement of metal wires. It has become a major method of cutting silicon wafers and magnetic materials.

## © Highlights of the scheme

- It has high work efficiency, capable of producing several hundred of products at a time
- It has high precision and small cutting loss in product machining
- It features a constant swing bar output torque, steady tension of metal wires and swing bar jitter angle of less than  $\pm 1^\circ$
- Stably operating FPC can realize automatic deviation rectification and direction switching
- Spindles are directly coupled to realize synchronous closed-loop control between the spindles without additional linking mechanism and fast dynamic response
- The maximum linear cutting speed is 2000 m/min

## © Scheme composition

Comprising three parts, i.e. touch screen, motion controller and servo motor



# Stage lighting



## ◎ Industrial demand

As consumption level constantly improves and recreational activities diversify, new performance venues and forms emerge one after another in the market, large-scale stage machinery and theater equipment of high technology are introduced, and equipment used is generally becoming more complicated. To render spectators better visual experience requires diversified stage performances and innovation, which can not only promote creativity conversion and art presentation, but also enhance the overall effect of stage scenes and treat the spectators with a feast of aesthetic enjoyment. SINEE stage control systems, featuring high safety, diversity, flexibility and easy operation, are powerful aids for stage scenes and actions.

## ◎ Highlights of the scheme

- Support multi-mode switch control
- Support multiple protection functions
- Easy and simple cable connection
- Support storage of massive formula data with stable communication

## ◎ Scheme composition

EA180 series servo system